



model  
**SFTHCTS742WFI**  
Commercial

*Thermostat*

# High Resolution Digital Thermostat

Full Color  
Touch Screen Display  
with Wi-Fi



## Owner's Manual and Installation Instructions



## CAUTION

Follow the [Installation Instructions](#) before proceeding. Set the thermostat mode to “OFF” prior to changing settings in setup or restoring Factory Defaults.

---

This device complies with Part 15 of the FCC Rules. Operation is subject to the following two conditions: (1) this device may not cause harmful interference, and (2) this device must accept any interference received, including interference that may cause undesired operation.

---

This color touch screen has the ability to receive updates to its firmware. Periodically firmware updates are released by the manufacturer to add features and/or performance enhancements. This manual was produced reflecting the most current firmware/feature set at the time of publication, firmware rev. 5.10. Firmware releases after rev. 5.10 may not be adequately depicted in this manual. Please refer to the appropriate website or contact your place of purchase to learn about changes to the thermostat after firmware release 5.10.

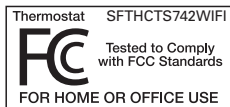

- Auto-Changeover:** A mode in which the thermostat will turn on the heating or cooling based on room temperature demand.
- Cool Setpoint:** The warmest temperature that the space should rise to before cooling is turned on (without regard to deadband).
- Deadband:** The number of degrees the thermostat will wait, once a setpoint has been reached, before energizing heating or cooling.
- Differential:** The forced temperature difference between the *heat setpoint* and the *cool setpoint*.
- Heat Setpoint:** The coolest temperature that the space should drop to before heating is turned on (without regard to deadband).
- Icon:** The word or symbol that appears on the thermostat display.
- Mode:** The current operating condition of the thermostat (i.e. Off, Heat, Cool, Auto, Program On).
- Non-Programmable Thermostat:** A thermostat that does not have the capability of running *Time Period Programming*.
- Programmable Thermostat:** A thermostat that has the capability of running *Time Period Programming*.
- Temperature Swing:** *Same as Deadband*.
- Time Period Programming:** A program that allows the thermostat to automatically adjust the *heat setpoint* and/or the *cool setpoint* based on the time of the day. *Same as Schedule*.

## **GET TO KNOW YOUR THERMOSTAT**

<i>Home Screen</i> .....	1
<i>Menu Screens</i> .....	1
<i>Dropdown Dashboard</i> .....	2
<i>Care and Use of your Thermostat</i> .....	3

## **QUICK START**

<i>Selecting your desired temperature and mode</i> .....	4
<i>Using the Fan button</i> .....	4
<i>Using the Override button</i> .....	5
<i>Setting the time &amp; date</i> .....	6
<i>Setting the time</i> .....	7
<i>Setting the date</i> .....	8

## **MAIN MENU BUTTONS**

<b>SCHEDULE</b> .....	9
<i>View My Schedule</i> .....	10
<i>Edit My Schedule</i> .....	10
<i>Unoccupied Settings</i> .....	11
<b>FAN SETTINGS</b> .....	12
<i>Fan On/Auto</i> .....	13
<i>Occupied Fan State</i> .....	13
<i>Preoccupancy Fan Purge</i> .....	13
<i>Preoccupancy Fan Purge Time</i> .....	13
<b>SCREENSAVER</b> .....	14
<i>Screensaver On/Off</i> .....	15
<i>ScreensaverSetup</i> .....	15
<i>Screensaver Preview</i> .....	15
<b>ALERTS</b> .....	16
<i>View Current Alerts</i> .....	17
<i>Reset Alerts</i> .....	17
<i>Set/Edit Reminders</i> .....	17
<i>Service Information (Who To Call For Service)</i> .....	17

<b>DISPLAY</b> .....	<b>18</b>
<i>Active Brightness</i> .....	<b>19</b>
<i>Idle Brightness</i> .....	<b>19</b>
<i>Night Dimmer</i> .....	<b>19</b>
<i>Maintenance</i> .....	<b>20</b>
<b>PREFERENCES</b> .....	<b>21</b>
<i>User Interface Themes</i> .....	<b>22</b>
<i>Custom Wallpaper</i> .....	<b>22</b>
<i>Heat/Cool Indicator</i> .....	<b>22</b>
<i>Backdrop On/Off</i> .....	<b>22</b>
<i>Sound Options</i> .....	<b>22</b>
<i>Show Outdoor Hi/Lo Options</i> .....	<b>22</b>
<b>HOLIDAYS</b> .....	<b>23</b>
<i>Holiday Schedule On/Off</i> .....	<b>24</b>
<i>Edit Holidays</i> .....	<b>24</b>
<i>Preset Holidays</i> .....	<b>26</b>
<b>SECURITY</b> .....	<b>27</b>
<i>Auto Screenlock</i> .....	<b>28</b>
<i>Setpoint Limits</i> .....	<b>28</b>
<b>INFORMATION</b> .....	<b>29</b>
<i>My Thermostat</i> .....	<b>30</b>
<i>View Runtime Graphs</i> .....	<b>30</b>
<i>Who to Call for Service</i> .....	<b>30</b>
<b>SETTINGS</b> .....	<b>31</b>
<i>Thermostat Name</i> .....	<b>34</b>
<i>Available Modes</i> .....	<b>34</b>
<i>SD Card (Import and Export)</i> .....	<b>34</b>

<b>GENERAL SETUP</b> .....	<b>34</b>
<i>Units (F or C)</i> .....	<b>34</b>
<i>Language</i> .....	<b>35</b>
<i>Smart Recovery On/Off</i> .....	<b>35</b>
<b>INSTALLATION SETTINGS</b> .....	<b>35</b>
<i>Heat &amp; Cool Stages</i> .....	<b>35</b>
<i>Heat &amp; Cool Stages</i> .....	<b>35</b>
<i>Compressor Stages</i> .....	<b>35</b>
<i>Aux Heat Stages</i> .....	<b>35</b>
<b>TIMERS &amp; DEADBANDS</b> .....	<b>35</b>
<b>HEAT PUMP SETTINGS</b> .....	<b>37</b>
<i>Heat Pump Lockout - Enabled/Disabled</i> .....	<b>37</b>
<i>Heat Pump Lockout Outdoor Temp</i> .....	<b>37</b>
<i>Aux Heat Lockout Enabled/Disabled</i> .....	<b>37</b>
<i>Aux Heat Lockout Temp</i> .....	<b>37</b>
<b>SENSOR SETTINGS</b> .....	<b>37</b>
<i>Control Sensor</i> .....	<b>37</b>
<i>Secondary Sensor Use</i> .....	<b>37</b>
<i>Calibrate Sensors</i> .....	<b>37</b>
<i>Fan Off Delay</i> .....	<b>38</b>
<i>Test Outputs</i> .....	<b>38</b>
<i>Dealer Information</i> .....	<b>39</b>
<i>Upgrade Firmware</i> .....	<b>39</b>
<i>Delete Custom Images</i> .....	<b>39</b>
<i>Reset to Factory Default Settings</i> .....	<b>39</b>
<i>Restart Thermostat</i> .....	<b>39</b>

<b>ACCESSORIES</b> .....	<b>40</b>
<i>Accessory Info</i> .....	<b>41</b>
<i>Setup</i> .....	<b>41</b>
<b>EMERGENCY HEAT</b> .....	<b>42</b>
<b>TOUCH SCREEN ATTENDANT</b> .....	<b>43</b>
<i>Installing the Touch Screen Attendant Software</i> .....	<b>44</b>
<i>Uploading Photos</i> .....	<b>44</b>
<b>INSTALLATION INSTRUCTIONS</b> .....	<b>45</b>
<i>Remove &amp; Replace the Old Thermostat</i> .....	<b>45</b>
<i>Wire Connections</i> .....	<b>46</b>
<i>The Touch Screen Thermostat Backplate</i> .....	<b>47</b>
<i>Explanation Of the Thermostat Dip Switches</i> .....	<b>48</b>
<i>Sample Wiring Diagrams</i> .....	<b>49</b>
<i>Outdoor and Remote Sensor Wiring Diagrams</i> .....	<b>51</b>
<b>TROUBLESHOOTING</b> .....	<b>52</b>
<b>WARRANTY</b> .....	<b>53</b>

## Home Screen

### Backlit Color Touchscreen Display

Outdoor Temperature  
(If optional accessory is installed)

#### Connectivity Symbol Table

	Not connected to Wi-Fi
	Connected to local access point w/IP address without Skyport access
	Connected to local access point w/IP address, but not yet connected to Skyport
	Connected to Skyport
No Wi-Fi Key detected	

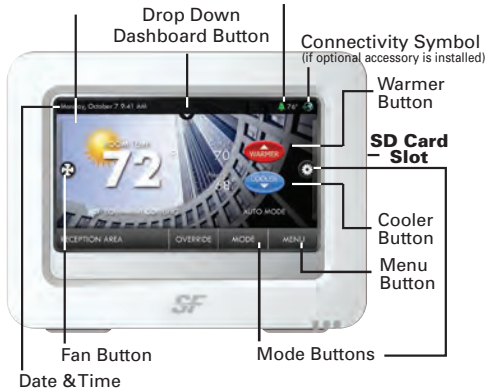

## Main Menu Screen



Back Button

Menu Buttons

Scrolling Buttons

## Sub Menu Screen

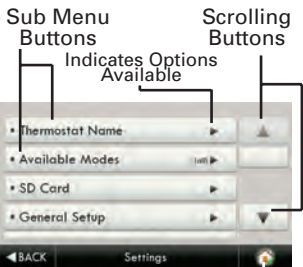

Home Button



## Dropdown Dashboard

The Dropdown Dashboard displays temperature and other readings. It will also show the high and low readings of the day.

### Drop Down Dashboard Button

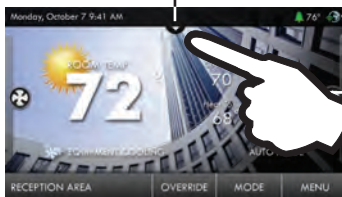

Wi-Fi  
Connection  
Icon

(The Skyport Wi-Fi Key is required for wi-fi connections. Model # SFTHATSWIFI)

### Dropdown Dashboard

(The contents of your Dashboard may vary)

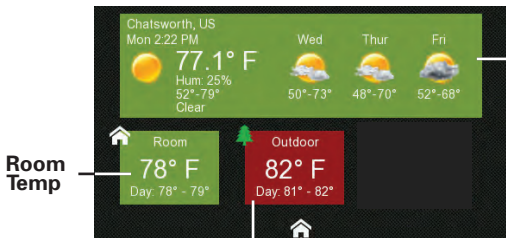

Weather  
Display

Room  
Temp

Outdoor Temp

Press the HOME button to return to the Home Screen

### Care and Use of Your Thermostat

Pencils, pens and other sharp objects should never be used on your thermostat; these may damage your touch screen. Only use your finger tip to press the touch screen buttons.



Use a soft, damp cloth to clean the screen.

**DO NOT USE ABRASIVE CLEANERS OR CLEANERS THAT CONTAIN SOLVENTS. DO NOT SPRAY ANYTHING DIRECTLY ONTO THE THERMOSTAT.**

## Selecting Your Desired Temperature and Mode

Press  or  to adjust temperature

The Heat or Cool Setpoint is the temperature the room has to reach before heating or cooling will turn off.

(Without regard to deadband)

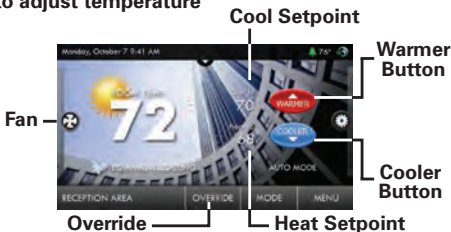

Press  or the MODE Icon 

**HEAT** will allow only heat operation.

**COOL** will allow only cool operation.

**AUTO** will allow both Heat and Cool operation.

**OFF** - heating and cooling systems are turned off.

**AUTO-CHANGEOVER MODE** - Pressing the WARMER or COOLER buttons in Auto mode will adjust both the heat and cool setpoints simultaneously. To adjust heat and cool setpoints individually, choose HEAT mode to adjust the heat setpoint and COOL mode to adjust the cool setpoint, then return to AUTO mode.

**HEAT OR COOL MODE** - Pressing the WARMER or COOLER buttons in Heat or Cool mode will adjust only the heat or cool setpoints.

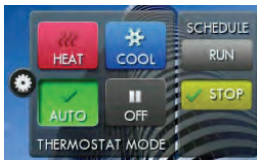

## Using the Fan Button

Press the FAN Icon 

**FAN ON** fan runs constantly except in OFF Mode.

**FAN AUTO** fan only runs with a heating or cooling demand.

NOTE: FAN button is disabled during Program Run Mode.



### Using the Override Button

#### OVERRIDE

**NOTE:** Override may only be used when the thermostat is set to Program RUN or Holiday ON modes.



Override

**Unoccupied Operation** - During programmed, unoccupied periods, pressing the **OVERRIDE** button will force the thermostat into Occupied 1 settings. When the **OVERRIDE** button is pressed, a timer screen will appear and allow the user to choose from 30 minutes to up to 4 hours of override time. To turn off the override timer, press the **OVERRIDE** button and when the timer screen appears, press **CANCEL OVERRIDE**.

**Occupied Operation** - During programmed, occupied periods, pressing the **OVERRIDE** button will force the thermostat into an unoccupied period for the rest of the day. During this forced unoccupied period the **OVERRIDE** button will operate as described above.

**Holiday Operation** - During Holiday Mode, pressing the **OVERRIDE** button will force the thermostat into Occupied 1 settings. When the **OVERRIDE** button is pressed, a timer screen will appear and allow the user to choose from 30 minutes to up to 4 hours of override time. To turn off the override timer, press the **OVERRIDE** button and when the timer screen appears, press **CANCEL OVERRIDE**.



**NOTE:** When the thermostat is connected to the Skyport; the Time & Date are automatically synchronized to the Skyport Cloud, including automatic Daylight Savings adjustments.

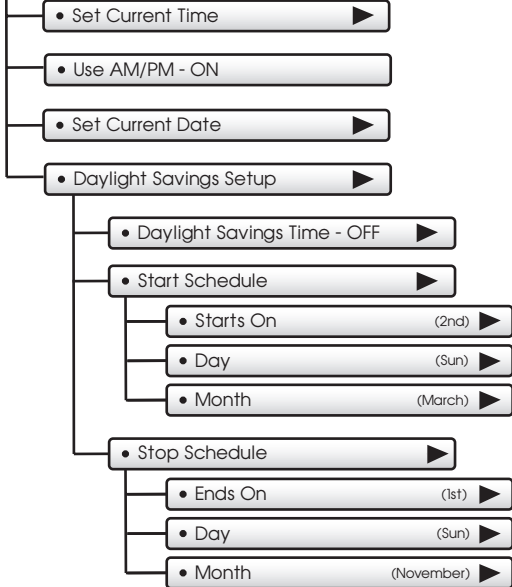

## Setting the Time

Press **MENU** then  to scroll down.

Press



Press



Press



and



to set the current time.

Press



when finished.

Choose



For 12 hour AM/PM clock



For 24 hour clock

Press



when finished.

## Setting the Date

• Set Current Date 6/1/2013 **Press**

**Press** or **to set the current month and year.**

**Press the day on the calendar**

Su	Mo	Tu	We	Th	Fr	Sa
27	28	29	30	1	2	3
4	5	6	7	8	9	10
11	12	13	14	15	16	17
18	19	20	21	22	23	24
25	26	27	28	29	30	31
1	2	3	4	5	6	7



**Press**

**when finished.**

• Daylight Savings Setup

**Turn Daylight Savings Time on or off.**

• Daylight Savings Time - OFF

• Daylight Savings Time - ON

**Adjust when Daylight Savings Time begins.**

• Start Schedule

• Starts On (2nd)

• Day (Sun)

• Month (March)

**Adjust when Daylight Savings Time ends.**

• Stop Schedule

• Ends On (1st)

• Day (Sun)

• Month (November)

**Press**

**after making a change to a selection.**

**Press**

**or the Home button when finished.**

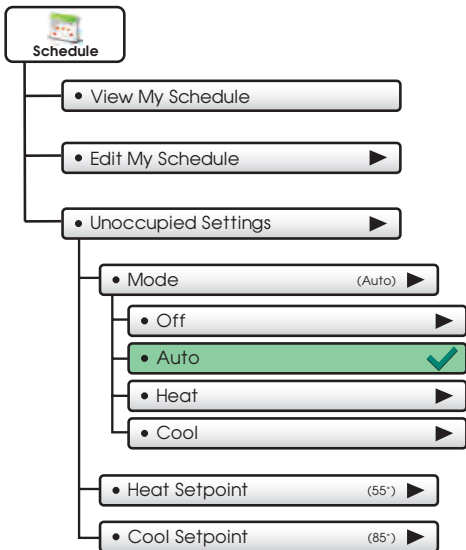



## Main Menu Buttons - Schedule



### Schedule

This thermostat features up to 3 Occupied time periods per 24 hour day.

#### • View My Schedule

Press a day of the week to view its settings. This may be repeated for each day.

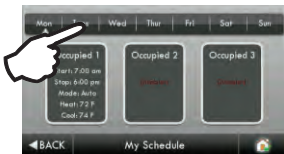

#### • Edit My Schedule

Press and select day(s) to program

Select individual days

or

Select groups of days

Then press **NEXT**



Press and select a Time Period (Occupied 1, Occupied 2, or Occupied 3) to edit.

#### TIP:

Occupied 2 will override Occupied 1 and Occupied 3 will override Occupied 1 & 2.

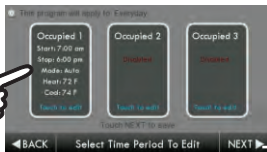

Next

## Main Menu Buttons - Schedule



### • Edit My Schedule

(Continued)

Adjust Mode, Start Time, Stop Time, and Heat and Cool Setpoints to desired settings. The Time Period may also be Enabled or Disabled. Unchecked the enabled box for Time Periods you don't want to use. Press **DONE** when finished.

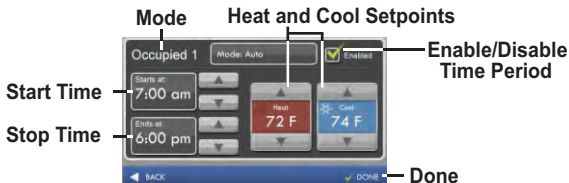

When you are finished editing the time periods press



Review your program.  
Press **SAVE** to keep your program.  
Press **EDIT** to make further changes.

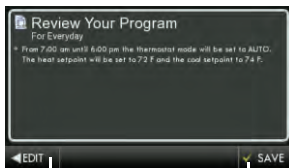

Edit

Save

### • Unoccupied Settings

Choose your Mode and Heat and Cool setpoints for the Unoccupied period.

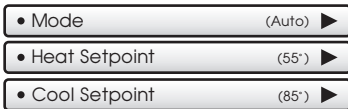

Press **MODE** or the MODE Icon



On the Home Screen to select to Run or Stop Schedule

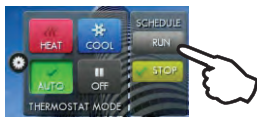

## Main Menu Buttons - Fan Settings

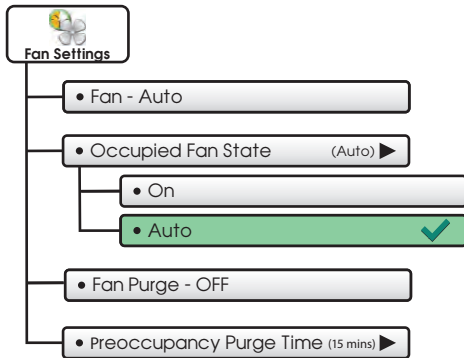

## Main Menu Buttons - Fan Settings



### Fan Settings

The fan may be set to run continuously during Heat, Cool, Auto, and Occupied modes. A Pre-Occupancy Fan Purge schedule may also be set.

Press to turn fan **On** to run continuously or **Auto** for fan to run only with heating or cooling.

• Fan - ON



• Fan - Auto

• Occupied fan state

(On)



Press to turn fan **On** to run continuously during Occupied mode or **Auto** for fan to run only with heating or cooling.

• Fan Purge - OFF



Press to turn on Preoccupancy Fan Purge. This feature allows the fan to run for a preset amount of time before Occupied 1 begins.

• Preoccupancy Purge Time (15 mins)



The Preoccupancy Fan Purge timer may be set from 15 minutes to 3 hours in 15 minute increments.

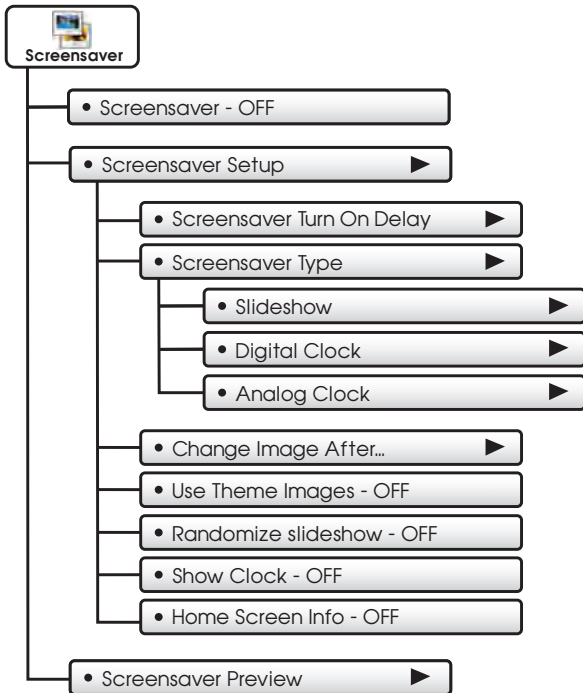



The Screensaver allows you to create custom slideshows.

• Screensaver - OFF

• Screensaver - ON 



• Screensaver Setup 

• Screensaver Turn On Delay (5m) 

How long after a button press for the Screensaver to appear. 1, 3, 5, or 30 minutes

• Screensaver Type (Slideshow) 

Slideshow, Digital Clock, Analog Clock

• Change Image After... 

15, 30 seconds - 1, 5, or 10 minutes

• Use Theme Images - ON 

Uses the included Theme Images for the Slideshow

• Randomize Slideshow - OFF 

Shuffles slideshow photos in random order

• Show Clock - OFF 

Shows the time and date every 5 photos. Off or On

• Home Screen Info - OFF 

Shows the mode, setpoints, and temperature after every 10 photos. Off or On.

• Screensaver Preview 

Press this button to preview your screensaver operation before returning to the Home Screen.

After the preview, press anywhere on the screen to return to the sub menu.

## Main Menu Buttons - Alerts

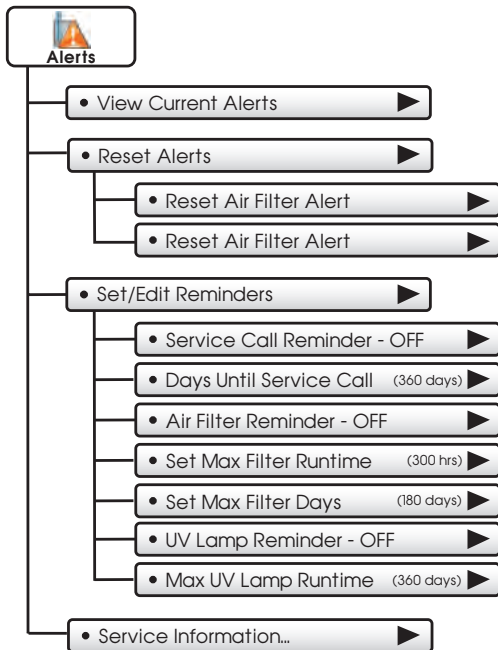

## Main Menu Buttons - Alerts



### Alerts

The alerts let you know when your system needs service.

#### • View Current Alerts

View and reset current service alerts here.



Alerts will appear on the bottom bar of the Home Screen. Press to view and reset current alerts.



#### • Reset Alerts

Clear and reset current service alerts.

#### • Set/Edit Reminders

Set service alert runtimes and turn reminders on or off.

• Service Call Reminder - OFF

• Days Until Service Call (360 days)

• Air Filter Reminder - OFF

• Set Max Filter Runtime (300 hrs)

• Set Max Filter Days (180 days)

• UV Lamp Reminder - OFF

• Set Max UV Lamp Runtime (360 days)

#### • Service Information...

View your service company's contact information.

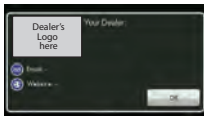



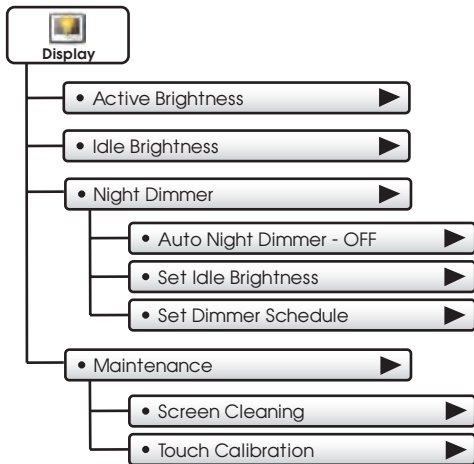



### Display

The display brightness options may be adjusted in this menu.

- Active Brightness (80%) ▶

You may select how bright the backlight is while the thermostat is active. The display is active for 3 minutes after last touch, it then goes Idle.

- Idle Brightness (30%) ▶

You may select how bright the backlight is while the thermostat is idle.

- Night Dimmer ▶

You may dim the brightness of the ColorTouch screen at night.

- Auto Night Dimmer - OFF

The screen can be set to dim automatically at night. Dimming the display can prolong the life of the backlight.

- Set Idle Brightness (50%) ▶

Set the screen brightness for the Night Dimmer. When Night Dimmer is On, the display will go idle 8 seconds after last touch.

- Set Dimmer Schedule ▶

Set the schedule for the Night Dimmer.

### • Maintenance

Maintenance allows you to clean and calibrate the touch screen.

### • Screen Cleaning

Screen Cleaning Mode disables the touch feature for 15 seconds so the screen may be cleaned without altering any settings.



Use a soft cloth without solvents or abrasive cleaners

### • Touch Calibration

Under normal circumstances, the touchscreen should not need to be calibrated.

Touch the center of the targets as they appear on the screen.

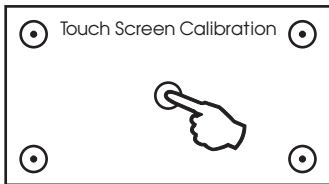

Press **FINISH** when done.

When calibration is complete, the thermostat will automatically restart and return to the Home Screen.

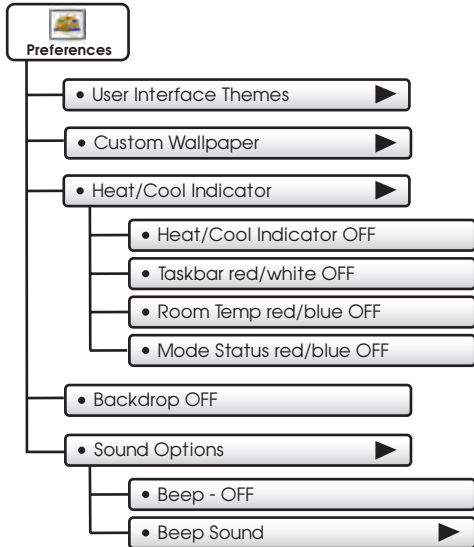



### Preferences

You may set the type of background that appears on the thermostat Home Screen.

#### • User Interface Themes (Buildings) ▶

This thermostat has several high quality background themes to choose from.

**NOTE:** At 7 PM, the background will change to an evening scene and the moon will replace the sun. At 7 AM it will return to a daytime scene.

#### • Custom Wallpaper ▶

You may choose your own background image by selecting a photo that you have uploaded from an SD memory card.

#### • Heat/Cool Indicator ▶

You may choose an enhanced indicator of the current status of the HVAC equipment.

- Heat/Cool Indicator - ON/OFF
- Room Temp Red/Blue - ON/OFF
- Taskbar Red/White - ON/OFF
- Mode Status Red/Blue - ON/OFF

#### • Backdrop - OFF

The Backdrop makes numbers and words easier to read, and may be needed on certain background images.

#### • Sound Options ▶

- Beep - ON

Turn the beep sound on or off.

- Beep Sound (Beep 1) ▶

Choose from different beep sounds.

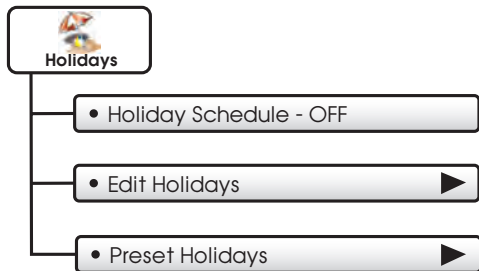



## Holidays

The Holiday Schedule allows the Touch Screen to follow a fully customizable preset, weekly, monthly, and yearly holiday program. The thermostat will Holidays stay in Unoccupied settings while Holiday is active.

### • Holiday Schedule - OFF

Press to turn Holiday Schedule **On** or **Off**.

### • Edit Holidays

Start by selecting a Holiday

You may continue to select more holidays or you can press the **Repeat** button for recurring holidays.

Pressing a selected holiday will deselect that holiday



## Using the Repeat Button

Choose to repeat the holiday every week, month or year. Or, press **CANCEL** to go back.

If you choose to repeat the holiday every week, you will be prompted to confirm the day of the week to be repeated.

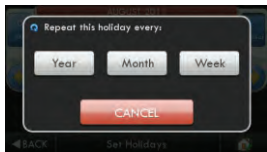

## Using the Info Button

Press the **Info** button to view how non-holidays, holidays, and exceptions to repeating holidays will appear on the Holiday calendar.

Continued

• Edit Holidays



(Continued)

## Deselecting Holidays

You may deselect a holiday simply by pressing on it.

Press **BACK** to save your changes and return to the Holiday menu.

If you choose to deselect a holiday that is part of a Custom Repeating Program, the screen below will appear.



---

## Marking Non-Holidays

You will now be prompted to mark this day only as a non-holiday or edit **All** repeating holidays that affect this day.

Press **SAVE** to mark only this day as a non-holiday.

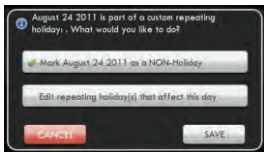

If you choose to edit repeating holidays that affect this day, press **NEXT** and the next screen will appear.

---

## Editing Repeating Holidays

If, for example, you choose to repeat the holiday every month, the following screen will appear:

You may now choose to repeat the holiday:

- On the 25th of every month
- On the 4th Monday of every month
- On the last Monday of every month

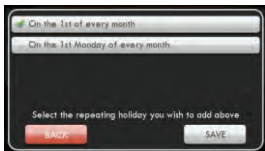

Press **SAVE** to save your changes and return to Holiday programming.





### • Edit Holidays

(Continued)

#### Editing Repeating Holidays (continued)

You may now delete all repeating custom holidays in this group by pressing the **ON** box to uncheck your selection. Press **SAVE** to return to Holiday editing screens.

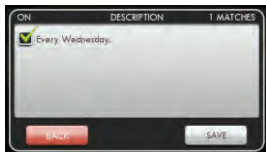

### • Preset Holidays

You may choose from several standard preset holidays to observe. When the preset holidays are set to **ON**, they will be observed every year on that date.

#### Overriding Holiday Mode

You may override Holiday Mode by pressing the **OVERRIDE** button and choosing the amount of override time desired.

#### Turning Off Holiday Mode From the Homescreen

You may turn off Holiday Mode by pressing the **MODE** button and then pressing the Holiday **STOP** button.

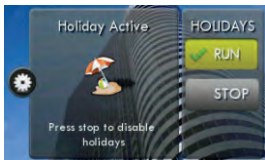

## Main Menu Buttons - Security

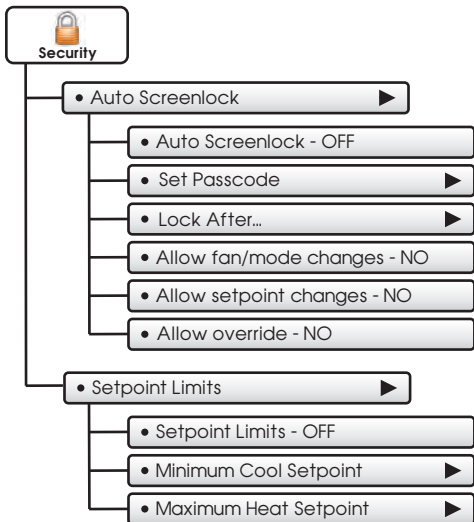



Security settings may be set to limit or prevent changes to your thermostat.

### • Auto Screenlock

• Auto Screenlock - OFF

• Auto Screenlock - ON

• Set Passcode

(code not set)

**NOTE:** Code must be set before Auto Screenlock can be turned on.

Use keypad to enter and confirm passcode.



When the thermostat is locked, the bottom bar of the display will show:

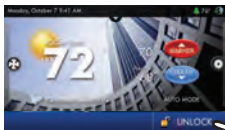

Press **UNLOCK** then enter passcode to access thermostat settings.

• Lock After...

(5 m)

Set the time the screen will automatically lock after the last button press.

• Allow fan/mode changes - NO

Choose to allow mode changes when Auto Screenlock is on.

• Allow setpoint changes - NO

Choose to allow setpoint changes when Auto Screenlock is on.

• Allow override - NO

Choose to allow use of the Override button when Auto Screenlock is on.

### • Setpoint Limits

Limits how high or low heating and cooling may be adjusted.

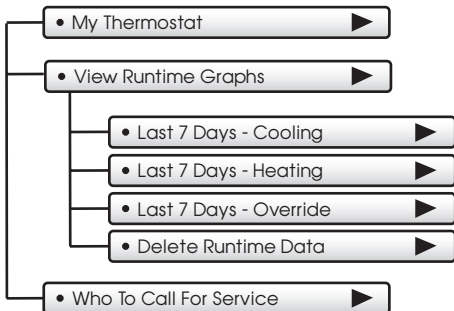



Information

This button contains valuable service and system runtime information.

• My Thermostat

View your thermostat dip switch settings, equipment status, runtimes, and other settings.

• View Runtime Graphs

Track your system's runtime/energy usage.

• Last 7 Days - Cooling

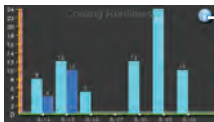

Press the information icon to learn more about each graph

• Last 7 Days - Heating



Press anywhere on the screen to return to the submenu.

• Last 7 Days - Override

Press to view a graph of override runtime information.

• Delete Runtime Data

Press to delete your current equipment runtime information.

• Who To Call For Service

Your service company's contact information is displayed here.

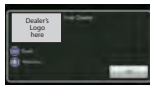

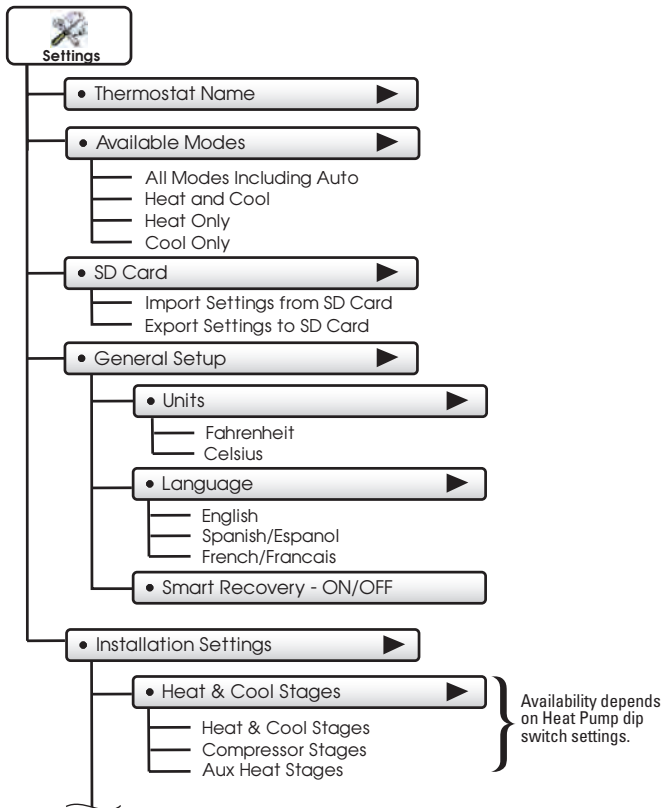

(Continued next page)



Settings

• Installation Settings ▶ (Continued)

• Timers & Deadbands ▶

- Cycles Per Hour
- Min Heat/Cool Difference
- Compressor Min Off Time
- 1st Stage Deadband
- 2nd Stage Deadband
  - 2nd Stage Deadband
  - 2nd Stage Timer
  - 2nd Stage Turnoff Point
    - Deadband
    - Setpoint
- 3rd Stage Deadband
  - 3rd Stage Deadband
  - 3rd Stage Timer
  - 3rd Stage Turnoff Point
    - Deadband
    - Setpoint
- 4th Stage Deadband
  - 4th Stage Deadband
  - 4th Stage Timer
  - 4th Stage Turnoff Point
    - Deadband
    - Setpoint

• Heat Pump Setting ▶

- Heat Pump Lockout - Enabled/Disabled
- HP Lockout Outdoor Temp
- Aux Heat Lockout - Enabled/Disabled
- Aux Heat Lockout Temp

(Continued next page)



Settings

• Installation Settings ▶ (Continued)

• Sensor Settings ▶

Control Sensor

Thermostat Sensor Only

Wired Sensor Only

Average Wired/Thermostat

Wired Sensor Use

Use as Outdoor Sensor

Use as Remote Sensor

Use as Supply Sensor

Use as Return Sensor

Calibrate Sensors

Thermostat

Wired Sensor

• Fan Off Delay ▶

• Test Outputs ▶

• Dealer Information ▶

Dealer Name

Contact Name

Dealer Phone

Dealer Email

Dealer Website

• Upgrade Firmware ▶

• Delete Custom Images ▶

• Factory Defaults ▶

• Restart Thermostat ▶





Thermostat heating and cooling options are found in this menu

## • Thermostat Name ▶

Use keypad to name your thermostat. The name is displayed on the Home Screen.

(Up to 14 characters)

Name appears here

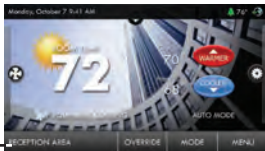

## • Available Modes (all) ▶

Choose the desired modes the thermostat will use: Heat, Cool, Heat & Cool, or Auto (All). For example, if you only have a heater, choose Heat, and only Heat & Off modes will be available. This will simplify the operation for the user.

## • SD Card ▶

Import and export files to and from the thermostat. See the **TouchScreen Assistant** instructions for further details.

### • Import Settings from SD Card ▶

Upload files from TouchScreen Assistant or another thermostat.

### • Export Settings to SD Card ▶

Export files from one thermostat and import them into others.

**\*NOTE:** A 2GB SD card is recommended. To import and export files, the SD card must contain the same version of the firmware as the thermostat. TouchScreen Assistant will keep the firmware current.

## • General Setup ▶

### • Units (F) ▶

- Fahrenheit (F)
- Celsius (C)

## • General Setup ▶

(Continued)

### • Language (en) ▶

- English
- Spanish/Español
- French/Français

### • Smart Recovery - OFF

### • Smart Recovery - ON ✓



Smart Recovery turns on the heat before the Morning start time to bring the room temperature to the Morning setpoint at the start of the Morning time period. Please allow 4-8 days for Smart Recovery time to adjust. When used with a heat pump, electric strip heat will be disabled while Smart Recovery is active.

## • Installation Settings ▶

### • Heat & Cool Stages (1h1c) ▶

#### • Heat & Cool Stages (1h1c) ▶

Up to 2 Stages Cooling and 4 stages Heating.

#### • Compressor Stages (1h1c) ▶

Up to 2 compressors.

#### • Aux Heat Stages (1h1c) ▶

0 to 2 stages of Aux Heating.

} Only available when dip switch is set for Heat Pump operation.

## • Timers & Deadbands ▶

### • Cycles Per Hour (6) ▶

At 6 cycles per hour, the HVAC unit will only be allowed to energize once every 10 minutes. The Cycles Per Hour limit may be overridden and reset by pressing the WARMER or COOLER buttons. (2, 3, 4, 5, 6, No Limit)

• Installation Settings ▶

(Continued)

• Timers & Deadbands ▶

(Continued)

• Min Heat/Cool Difference (2°) ▶

The minimum gap between Heat and Cool setpoints. (0 - 6 deg. F)

• Compressor Min OFF Time (5m) ▶

None, 1 minute, or 5 minutes.

**The Deadband is the number of degrees or minutes that the thermostat waits before it initiates the stages of heating or cooling.**

**1st Stage Deadband** Specifies the minimum temperature difference between the room temperature and the desired setpoint before the first stage of heating or cooling is allowed to turn on. For example, if the heat setpoint is 68° and the 1st Stage deadband is set to 2 degrees, the room temperature will need to drop to **66 degrees** before the heat turns on.

• 1st Stage Deadband (2°) ▶

(1 - 6 deg. F)

• 2nd Stage Deadband ▶

• 2nd Stage Deadband (2°) ▶

Number of degrees past 1st stage before 2nd stage turns on. (0 - 10 deg. F)

• 2nd Stage Timer (2mins) ▶

Number of minutes past 1st stage before 2nd stage turns on. (0 - 60 mins.)  
(The 2nd stage deadband must also be met)

• 2nd Stage Turnoff Point (Deadband) ▶

Deadband or Setpoint.

• 3rd Stage Deadband ▶

• 4th Stage Deadband ▶

The 3rd and 4th stage deadband settings have the same adjustable steps as 2nd stage deadband.

## Main Menu Buttons - Settings



• Installation Settings ▶ (Continued)

• Heat Pump Settings ▶

(Only available when dip switch is set for Heat Pump operation.)

• Heat Pump Lockout - DISABLED ▶

• Heat Pump Lockout - ENABLED ✓

Turns on Heat Pump Lockout.

• HP Lockout Outdoor Temp (65°) ▶

Heat Pump will not run below this temp. (0° - 75° F)

• Aux Heat Lockout - DISABLED ▶

• Aux Heat Lockout - ENABLED ✓

Turns on Aux Heat Lockout.

• Aux Heat Lockout Temp (65°) ▶

Aux Heat will not run above this temp. (0° - 75° F) **GAS/EL** or **HP** dip switch must be set for **HP** and **GAS** or **ELEC** dip switch must be set for **ELEC**.

For Lockout Temperatures:  
A local outdoor sensor connected to the thermostat is required.  
Skyport supplied outdoor temperature will not work in place of a local sensor.

• Sensor Settings ▶

• Control Sensor (thermostat) ▶

When a remote sensor is connected to the thermostat, the user may choose which sensor source is used to measure room temperature.

- Thermostat sensor only
- Wired Sensor only
- Average remote/thermostat

• Wired Sensor Use (remote) ▶

The wired sensor may be used as follows:

- Outdoor sensor
- Remote Sensor
- Supply Sensor
- Return Sensor

• Calibrate Sensors (0°) ▶

The thermostat and wired sensor may be calibrated -7° to +7° F.

## Main Menu Buttons - Settings



• Installation Settings ▶ (Continued)

• Fan Off Delay (0s) ▶

Runs the fan for a short time after Cooling or electric strip heat turns off to increase system efficiency. (0 - 120 Secs.)

• Test Outputs ▶

The installer or service technician can use this feature to test the functions without any time delays of the thermostat and heating and cooling equipment.

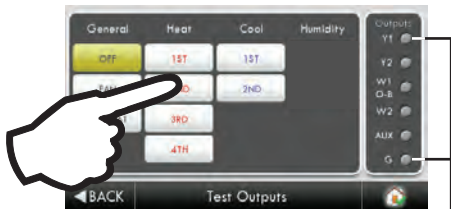

With a 1st stage cooling call, Y1 and G are active

### • Dealer Information

A Dealer may enter their company contact information for the customer to use when they need service. This will appear when the “Who To Call For Service” button is pressed in the Information Menu.

Press the buttons below and use the keyboard to enter your information.

- Dealer Name
  - Contact Name
  - Dealer Phone
  - Dealer Email
  - Dealer Website
- Please use TouchScreen Assistant to add Dealer's logo.**  
(See Page 43)

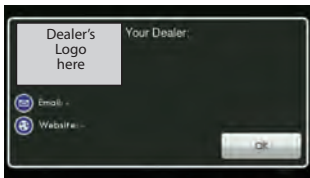

### • Upgrade Firmware

Press to upgrade the thermostat firmware. The SD Card must be in the thermostat SD Card reader and contain the valid firmware. If an error message appears, confirm with TouchScreen Assistant that firmware is up to date or simply try reinserting the SD card.

**If you are connected to Skyport Wi-Fi and you receive an Alert that new firmware is available, simply press the Upgrade Firmware button to upgrade wirelessly.**

**Note:** Occasionally an update that requires a large amount of data is not possible to do wirelessly. In this case an update using an SD card will be required.

### • Delete Custom Images

Press to delete the custom photos you uploaded to the thermostat.

### • Factory Defaults

Press to reset the thermostat back to the factory settings.

### • Restart Thermostat

If needed, press here to restart the thermostat.

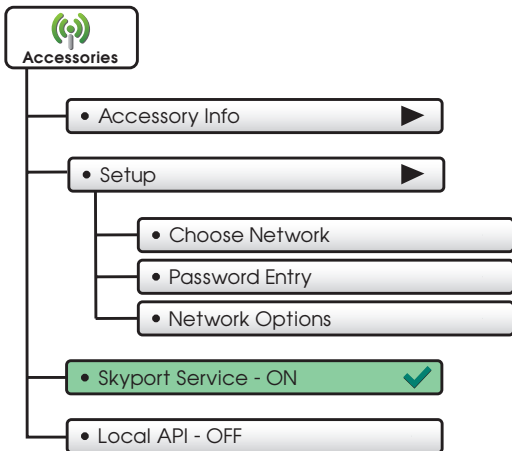

### • Accessory Info

It is here that you will find helpful information regarding the connectivity status of your thermostat, including the thermostat's ID.



### • Setup

Upon pressing setup, the thermostat will search for available local networks with which to connect. After identifying local access points, you will be prompted to choose a network, enter a password and other network options.



### • Skyport Service - ON

Enable the thermostat to connect to the Skyport Cloud for remote monitoring and control features.

### • Local API - OFF

Enabling the local API allows 3rd party software to interface with your thermostat, such as a home automation system.





Emergency Heat

The Emergency Heat function is only available if your thermostat is set to control a Heat Pump.

To initiate the Emergency Heat feature, Press the Emergency Heat button. During Emergency Heat operation the thermostat will turn on the fan and auxiliary stages of heat when there is a demand for heat. The 1st stage of heating and all stages of cooling will be unavailable. To exit Emergency Heat, press the Emergency Heat button.

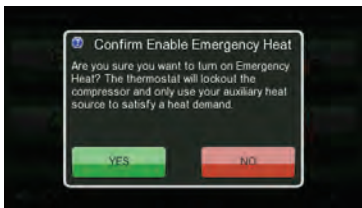

Touch Screen Attendant may be downloaded at no charge at:

**sfthermostats.com**



Every time the user runs the Touch Screen Attendant software, it automatically connects to the SF Touch Screen Attendant website in the background and updates the software and firmware (the operating system for TSA) at no cost.

**The Touch Screen Attendant** allows you to use your computer to:

- Upload photos for background and slideshow images
- Configure installation settings
- Program a time period schedule
- Upload dealer and service contact information and company logo
- Update thermostat firmware

## Uploading Photos and Settings to your thermostat

When you are finished adding and editing photos and settings, click on **Save to SD**. When prompted, remove the SD card from the SD card reader on your computer.



**Save to SD**

\*NOTE: A 2GB SD card is recommended.

---

## At the thermostat:

Insert the SD card into the SD Card Slot.

Press

**MENU**

then



Next, press



Press

• SD Card



SD Card Slot

Then press

• Import Settings from SD Card

Select the items to import into your thermostat then press

**NEXT**

Your thermostat will automatically save your new photos and settings in it's internal memory. When finished, you may remove the SD card. It is not needed for normal thermostat operation.

## Remove and Replace the old thermostat

To install the thermostat properly, please follow these step by step instructions. If you are unsure about any of these steps, call a qualified technician for assistance.

- Assemble tools: Flat blade screwdriver, wire cutters and wire strippers.

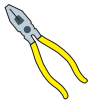

- Make sure your Heater/Air Conditioner is working properly before beginning installation of the thermostat.
- Carefully unpack the thermostat. Save the screws, any brackets, and instructions.
- Turn off the power to the Heating/Air Conditioning system at the main fuse panel. Most residential systems have a separate breaker for disconnecting power to the furnace.
- Remove the cover of the old thermostat. If it does not come off easily, check for screws.
- Loosen the screws holding the thermostat base or subbase to the wall and lift away.
- Disconnect the wires from the old thermostat. Tape the ends of the wires as you disconnect them, and mark them with the letter of the terminal for easy reconnection to the new thermostat.
- Keep the old thermostat for reference purposes, until your new thermostat is functioning properly.

## Wire Connections

If the terminal designations on your old thermostat do not match those on the new thermostat, **refer to the chart below or the wiring diagrams that follow.**

Wire from the old thermostat terminal marked	Function	Install on the new thermostat connector marked
G or F	Fan	G
Y1, Y or C	Cooling	Y1
W1, W or H	Heating	W1/O/B
Rh, R, M, Vr, A	Power	R
C	Common	C
O/B	Rev. Valve	W1/O/B*
W2	2nd Stage Heat	W2
Y2	2nd Stage Cooling	Y2
W3	3rd Stage Heat	W3
OUT -	Outdoor Sensor	SENSOR
OUT +	Outdoor Sensor	SENSOR
S1	Remote Sensor	SENSOR
S2	Remote Sensor	SENSOR

\* O/B is used if your system is a Heat Pump.

## The SFTHCTS742WFI Thermostat Backplate

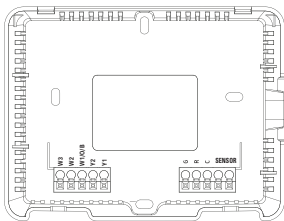

### NOTE:

The backplate does not fully cover a full size vertical junction box. The Touch Screen Wallplate (model# SFTHATSWP) or a single-gang, horizontally mounted junction box would be needed for that type of installation.

### To remove the thermostat backplate:

Using the Finger Pull Areas, pull the front housing away from the backplate.



Look for these tabs to locate the pull areas

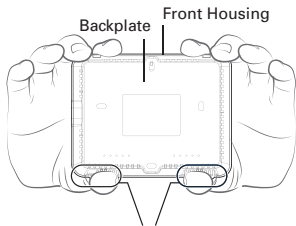

Pull out with thumbs in these areas

W3	3rd stage heat circuit/2nd stage aux heat
W2	2nd stage heat circuit/ 1st stage aux heat
W1/O/B	1st stage heat circuit/reversing valve
Y2	2nd stage compressor relay
Y1	1st stage compressor relay
G	fan relay
R	24 VAC return
C	24 VAC common
SENSOR	remote/outdoor/supply/return sensor connections

**IMPORTANT: This thermostat requires both R (24 VAC Return) and C (24 VAC Common) be connected to the backplate terminals.**

## Explanation of Thermostat Dip Switches

Dip switches are located on the back of the thermostat

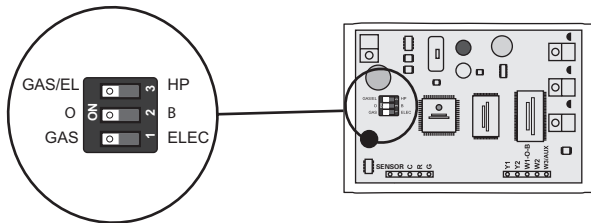

### GAS/EL HP GAS/EL HP



This dip switch configures the thermostat to control a conventional gas/electric system or a heat pump. If your system is anything other than a heat pump, leave this switch set for **GAS/EL**.\*

*\*For some commercial heat pumps, this switch may need to be set for GAS/EL. Consult the commercial heat pump literature.*



When the **GAS/EL or HP** dip switch is configured for **HP**, this dip switch (O or B) must be set to control the appropriate reversing valve. If **O** is chosen, the **W1/O/B** terminal will energize in cooling. If **B** is chosen, the **W1/O/B** terminal will energize in heating.



### \*When GAS/EL or HP is set for GAS/EL:

This switch (GAS or ELEC) controls how the thermostat will control the Fan (**G**) terminal in heating mode. When **GAS** is chosen, the thermostat **will not** energize the Fan (**G**) terminal in heating. When **ELEC** is chosen the thermostat **will** energize the fan in heating.

### \*When GAS/EL or HP is set for HP:

This switch (GAS or ELEC) defines the Aux Heat type. When **GAS** is chosen, the auxiliary heat will not be allowed to run during heat pump operation. When **ELEC** is chosen, up to two stages of auxiliary strip heat will be allowed to run.

## Sample Wiring Diagrams with Dip Switch Positions

### Conventional Heating and Cooling Systems

#### 2 Wire, Heat Only

Residential & Commercial 1 Stage Heating with no Fan.

**The thermostat will not work with 2 wires. Either pull new wire or purchase a model TSTATGAC-2W two-wire kit**

GAS/EL		HP
O		B
GAS		ELEC

#### 3 Wire, Heat Only

Residential & Commercial 1 Stage Heating with no Fan.

R	24VAC Power
C	24VAC Common
W1/O/B	1st Stage Heat

GAS/EL		HP
O		B
GAS		ELEC

#### 4 Wire, Cool Only

Residential & Commercial 1 Stage Cooling.

R	24VAC Power
C	24VAC Common
Y1	1st Stage Cool
G	Fan

GAS/EL		HP
O		B
GAS		ELEC

#### 5 Wire, 1 Stage Cooling, 1 Stage Heat

Residential & Commercial 1 Stage Cooling, with 1 stage Gas Heat.

R	24VAC Power
C	24VAC Common
W1/O/B	1st Stage Heat
Y1	1st Stage Cool
G	Fan

GAS/EL		HP
O		B
GAS		ELEC

#### 5 Wire, 1 Stage Cooling, 1 Stage Heat

Residential & Commercial 1 Stage Cooling, with 1 stage Electric Heat.

R	24VAC Power
C	24VAC Common
W1/O/B	1st Stage Heat
Y1	1st Stage Cool
G	Fan

GAS/EL		HP
O		B
GAS		ELEC

#### 8 Wire, 2 Stage Cooling, 3 Stage Heat

Residential & Commercial 2 Stage Cooling, with 3 stage Gas Heat.

R	24VAC Power
C	24VAC Common
W1/O/B	1st Stage Heat
W2	2nd Stage Heat
W3/AUX	3rd Stage Heat
Y1	1st Stage Cool
Y2	2nd Stage Cool
G	Fan

GAS/EL		HP
O		B
GAS		ELEC



## Sample Wiring Diagrams with Dip Switch Positions

### Heat Pump Systems

#### 5 Wire, 1 Stage Cooling, 1 Stage Heat

Residential & Commercial Heat Pump with 'O' Reversing Valve

R	24VAC Power
C	24VAC Common
W1/O/B	Reversing Valve
Y1	1st Stage Compressor (Cool or Heat)
G	Fan

GAS/EL		HP
O		B
GAS		ELEC

#### 6 Wire, 1 Stage Cooling, 2 Stage Heat

Residential & Commercial Heat Pump with 'O' Reversing Valve

R	24VAC Power
C	24VAC Common
W1/O/B	Reversing Valve
Y1	1st Stage Compressor (Cool or Heat)
W2	Aux Heat
G	Fan

GAS/EL		HP
O		B
GAS		ELEC

#### 7 Wire, 2 Stage Cooling, 3 Stage Heat

Residential & Commercial Heat Pump with 'O' Reversing Valve.

R	24VAC Power
C	24VAC Common
W1/O/B	Reversing Valve
W2	3rd Stage Heat
Y1	1st Stage Compressor (Cool or Heat)
Y2	2nd Stage Compressor (Cool or Heat)
G	Fan

GAS/EL		HP
O		B
GAS		ELEC

(Number of Compressor Stages set to 2)

#### 8 Wire, 2 Stage Cooling, 4 Stage Heat

Residential & Commercial Heat Pump with 'O' Reversing Valve.

R	24VAC Power
C	24VAC Common
W1/O/B	Reversing Valve
W2	3rd Stage Heat
W3	4th Stage Heat
Y1	1st Stage Compressor (Cool or Heat)
Y2	2nd Stage Compressor (Cool or Heat)
G	Fan

GAS/EL		HP
O		B
GAS		ELEC

(Number of Compressor Stages set to 2)

## Sample Wiring Diagrams

**Outdoor Sensor: SFTHATSSSEN Temperature Sensor** 10K ohm sensor at 77F/25C.  
Negative Temperature Coefficient.

Use 18-22 gauge thermostat wire.

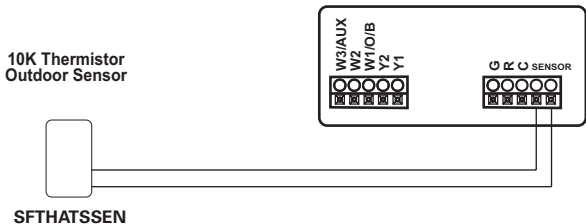

- **SYMPTOM:** The thermostat touch screen buttons are not responsive.  
**CAUSE:** The touch screen is out of calibration.  
**REMEDY:** Remove the thermostat from the backplate. Push the thermostat back onto the backplate, while keeping your finger pressed firmly against the center of the touch screen, until the Calibration screen appears. Re-calibrate the Touch Screen.
- **SYMPTOM:** The display is blank.  
**CAUSE:** Lack of proper power.  
**REMEDY:** Make sure the power is on to the HVAC and that you have 24vac between **R & C**.
- **SYMPTOM:** The air conditioning does not attempt to turn on.  
**CAUSE:** The cooling setpoint is set too high.  
**REMEDY:** Lower the cooling setpoint or lower the cooling set-point limit. *See Setpoint Limits (page 27).*
- **SYMPTOM:** The heating does not attempt to turn on.  
**CAUSE:** The heating setpoint is set too low.  
**REMEDY:** Raise the heating setpoint or raise the heating set-point limit. *See Setpoint Limits (page 27).*
- **SYMPTOM:** When controlling a residential heat pump, and asking for cooling, the heat comes on.  
**CAUSE:** The thermostat reversing valve dip switch is set for **"B"**.  
**REMEDY:** Set the reversing valve jumper for **"O"**.
- **SYMPTOM:** When calling for cooling, both the heat and cool come on.  
**CAUSE:** The thermostat equipment dip switch is configured for **"HP"** and the HVAC unit is a Gas/Electric.  
**REMEDY:** Set the equipment dip switch for **"Gas"**.
- **SYMPTOM:** Air handler control board fuse blows when thermostat is attached to backplate with power on, but does not blow until the thermostat is placed onto the backplate.  
**CAUSE:** The Outdoor sensor and/or sensor wiring is shorted.  
**REMEDY:** Check/replace Outdoor sensor and/or sensor wiring.

**One-Year Warranty** - This Product is warranted to be free from defects in material and workmanship. If it appears within one year from the date of original installation, whether or not actual use begins on that date, that the product does not meet this warranty, a new or remanufactured part, at the manufacturer's sole option to replace any defective part, will be provided without charge for the part itself provided the defective part is returned to the distributor through a qualified servicing dealer.

**THIS WARRANTY DOES NOT INCLUDE LABOR OR OTHER COSTS** incurred for diagnosing, repairing, removing, installing, shipping, servicing or handling of either defective parts or replacement parts. Such costs may be covered by a separate warranty provided by the installer.

**THIS WARRANTY APPLIES ONLY TO PRODUCTS IN THEIR ORIGINAL INSTALLATION LOCATION AND BECOMES VOID UPON REINSTALLATION.**

**LIMITATIONS OF WARRANTIES – ALL IMPLIED WARRANTIES (INCLUDING IMPLIED WARRANTIES OF FITNESS FOR A PARTICULAR PURPOSE AND MERCHANTABILITY) ARE HEREBY LIMITED IN DURATION TO THE PERIOD FOR WHICH THE LIMITED WARRANTY IS GIVEN. SOME STATES DO NOT ALLOW LIMITATIONS ON HOW LONG AN IMPLIED WARRANTY LASTS, SO THE ABOVE MAY NOT APPLY TO YOU. THE EXPRESSED WARRANTIES MADE IN THIS WARRANTY ARE EXCLUSIVE AND MAY NOT BE ALTERED, ENLARGED, OR CHANGED BY ANY DISTRIBUTOR, DEALER, OR OTHER PERSON WHATSOEVER.**

**ALL WORK UNDER THE TERMS OF THIS WARRANTY SHALL BE PERFORMED DURING NORMAL WORKING HOURS. ALL REPLACEMENT PARTS, WHETHER NEW OR REMANUFACTURED, ASSUME AS THEIR WARRANTY PERIOD ONLY THE REMAINING TIME PERIOD OF THIS WARRANTY.**

**THE MANUFACTURER WILL NOT BE RESPONSIBLE FOR:**

1. Normal maintenance as outlined in the installation and servicing instructions or owner's manual, including filter cleaning and/or replacement and lubrication.
2. Damage or repairs required as a consequence of faulty installation, misapplication, abuse, improper servicing, unauthorized alteration or improper operation.
3. Failure to start due to voltage conditions, blown fuses, open circuit breakers or other damages due to the inadequacy or interruption of electrical service.
4. Damage as a result of floods, winds, fires, lightning, accidents, corrosive environments or other conditions beyond the control of the Manufacturer.
5. Parts not supplied or designated by the Manufacturer, or damages resulting from their use.
6. Manufacturer products installed outside the continental U.S.A., Alaska, Hawaii, and Canada.
7. Electricity or fuel costs or increases in electricity or fuel costs for any reason whatsoever including additional or unusual use of supplemental electric heat.
8. ANY SPECIAL INDIRECT OR CONSEQUENTIAL PROPERTY OR COMMERCIAL DAMAGE OF ANY NATURE WHATSOEVER. Some states do not allow the exclusion of incidental or consequential damages, so the above may not apply to you.

This warranty gives you specific legal rights and you may also have other rights which may vary from state to state.

Patent Pending



Printed on recycled paper.  
P/N 88-1248 Rev. 1 06/18

