

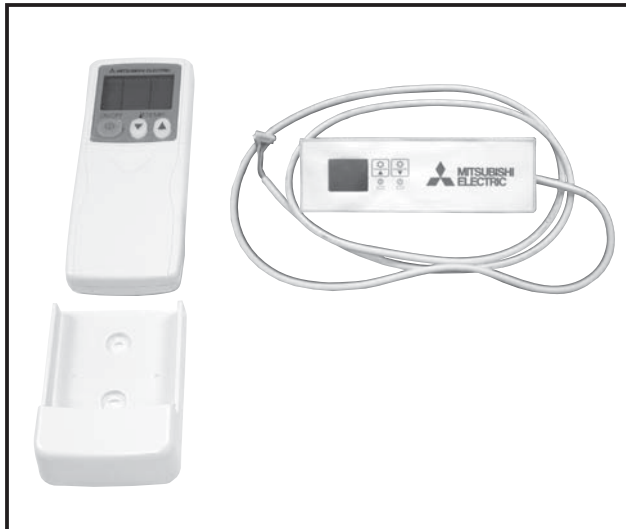

## Photo



## Descriptions

Enables the use of wireless remote controller for ceiling suspended models.

## Applicable Models

■ PCA-RP KA

## Specifications

Operation indication	During operation: LED (green) is lit, Alarm: LED (green) flashes.
Emergency operation	Cooler/heater button (start/stop) is provided.
Number of units controlled	Max. 16 refrigerant systems per group (One or more wireless light receivers must be installed for each refrigerant system.)
Adapter wiring	9-wire cord (standard accessory) with connector is connected to the connector (CN90) on the indoor unit control board.
Light receiver range	7m or less, at within 45 degrees to the front of receiver (the range varies with conditions)
Operating conditions	Temperature: 0 to 40°C , Humidity: 30 to 90% (no condensation)
Exterior	White gray (Munsell 4.48Y 7.92/0.66), ABS resin
Installation method	Attached to the brand label case of indoor unit.

## Dimensions

Unit : mm

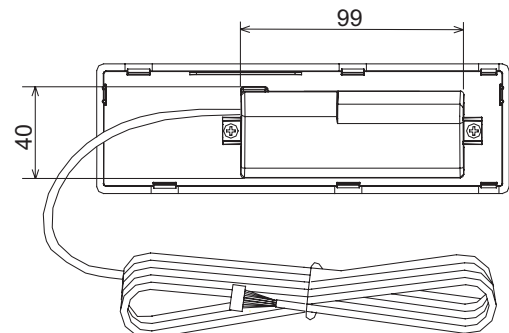
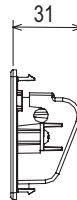
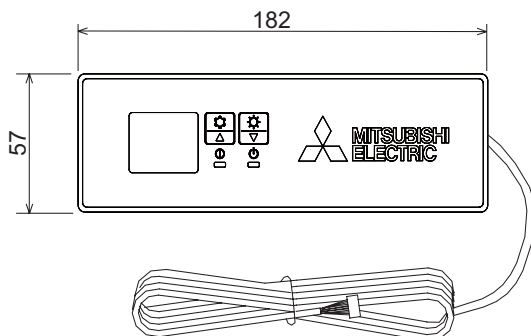

## How to Use / How to Install

### 1 Making Sure of Components

Make sure that the following components, along with this manual, are packed in the box.

Component	Q'ty
Wireless remote controller receiver	1
Wireless remote controller	1
Remote control holder	1
"AAA" LR03 alkaline batteries	2
4.1×16 wood screws	2
Cord retaining clips	2
Connection cord fixing seal (12×30 size)	1

### 2 How to Install

\* Be sure to turn the power off before installing.

#### ① Removing the intake grille and the right side panel

- Slide the catch holding the intake grille backwards to open the grille. Remove the screw holding the side panel, and then slide the side panel forward to remove it.

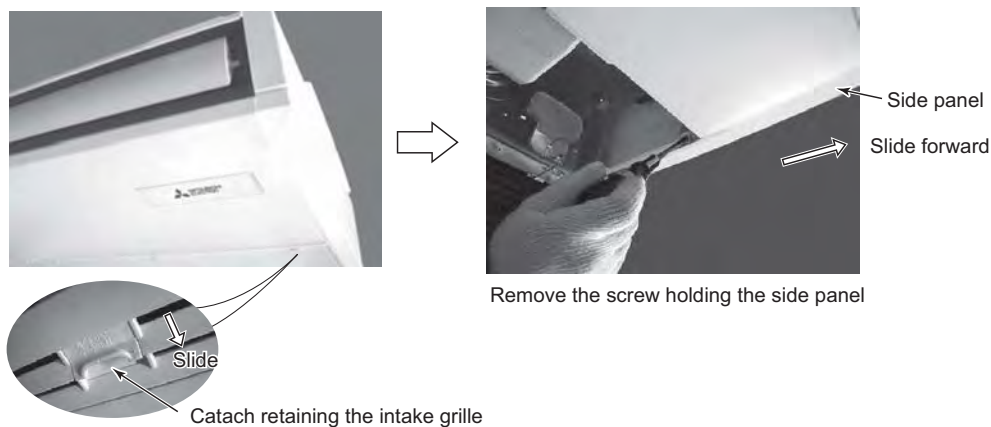

Remove the screw holding the side panel

#### ② Removing the existing brand label case

- Remove the brand label case (name plate with MITSUBISHI ELECTRIC) from the bottom right of the unit. If it is difficult to remove the case, use a flat-blade screwdriver, etc., taking care not to damage the panel.

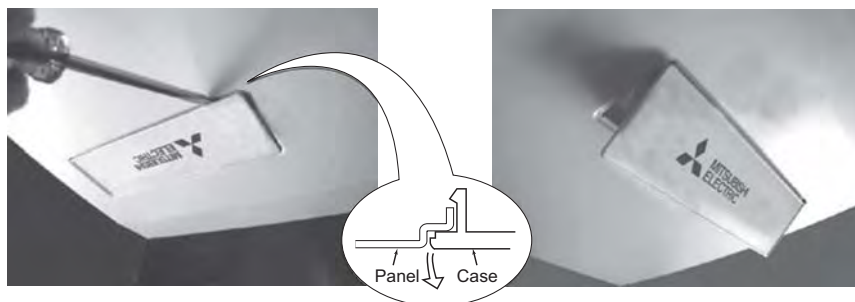

#### ③ Installing to the indoor unit

- Pass the receiver board connector through the right side of the square hole to which the brand label case was attached and then pull the connector and cord through the slit in the right side of the bottom panel.
- Fit the receiver into the square hole where the brand label case was attached.

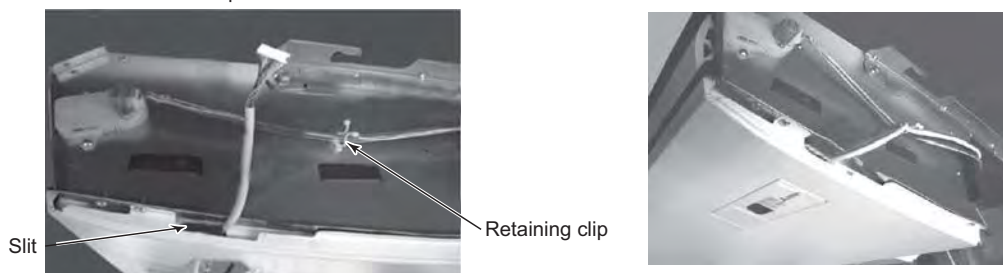

OPTIONAL PARTS

④ Laying out the lead wire

- Pass the lead wire for receiver through the retaining clips.
- Fix the lead wire for receiver with the clips on the ceiling side of the unit.

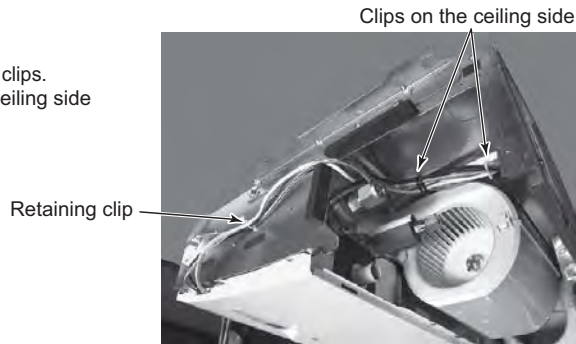

⑤ Removing the beam and the electrical box cover

- Remove the beam.
- Loosen the two screws at the bottom of the electrical box cover, and then slide the cover to the left to remove it.
- Pull down the electrical box.

Also on the opposite side { Electrical box fixing screw  
Electrical box cover fixing screw

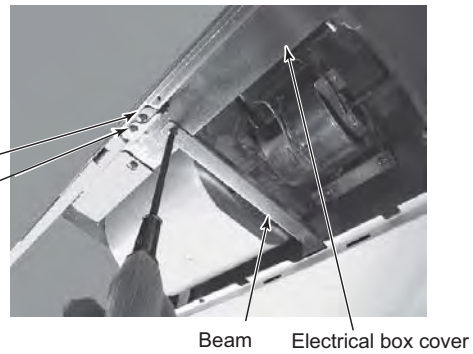

⑥ Connecting the receiver board connector to the control circuit board

- Pass the cord through the bush at the top right of the electrical box.
- Connect the connector to CN90 on the right of the control board.
- If the cord is loose, bundle it using the clamps under the above bush.

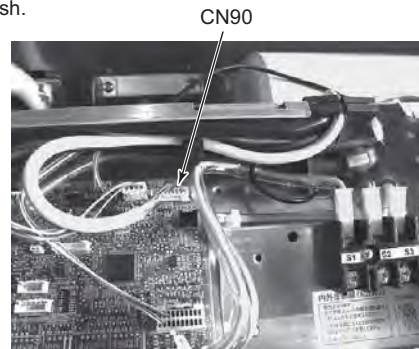
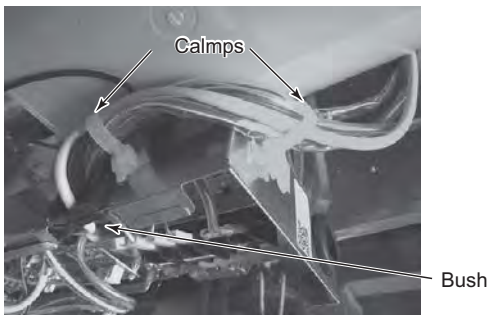

\* The positions of the connectors may be different according to the model. Please refer to the wiring diagram to confirm the positions of the connectors.

⑦ Reinstalling the removed components

- Reinstall the removed components in reverse order. (The brand level case is not needed.)

⑧ Remote control holder

- To install the wireless remote controller on a wall, first attach the remote control holder to a wall.

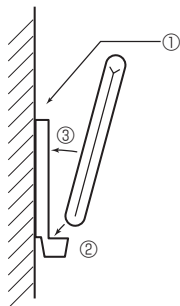

**Fitting remote control into holder**

- ① Fix the remote control holder to the wall using the 2 wood screws provided.
- ② Insert the remote control into the holder.
- ③ Push the remote control against the wall.

**Removing remote control**

- Pull the top of remote control forward.

**NOTE :** The remote signal will reach the receiver over a distance of approx. 7m in a straight line and approx. 45° left or right. If the infrared receiver is affected by fluorescent light (especially, inverter type), it may not be able to receive the signal. Take this into consideration when installing fluorescent lights or replacing them.

### 3 Pair Number Setting

- This is the setting to specify the unit to operate with the wireless remote controller.
- Make setting for J41, J42 (Jumper wire) of indoor controller board and the pair number of wireless remote controller.
- The pair number setting is available with the 4 patterns as shown in the following table. Make setting for the pair number (J41, J42) of indoor controller board and the pair number of wireless remote controller which is used as shown in the following table. \*The initial setting is Pair No. "0".

- ① Press the SET button with something sharp at the end.  
Start this operation from the status of remote controller display turned off.  
MODEL SELECT blinks and Model No. is lighted.
- ② Press the  $\square_{min}$  button twice continuously. Pair No. "0" blinks.
- ③ Press the temp  $\uparrow$   $\downarrow$  button to set the pair number you want to set.
- ④ Press the SET button with something sharp at the end.  
Set pair number is lighted for 3 seconds then turned off.

④ Pair No. of wireless remote controller	Indoor PC board
0	Initial setting
1	Cut J41
2	Cut J42
3 ~ 9	Cut J41, J42

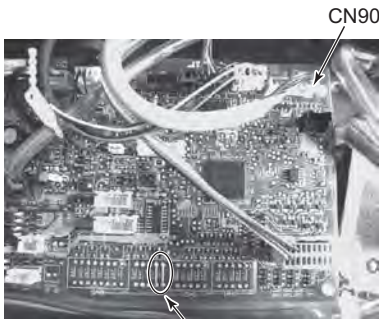

Jumper wire (J41, J42)

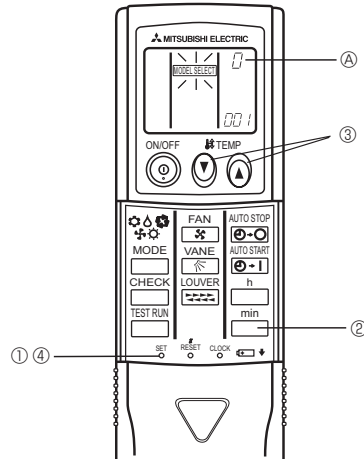

\* The positions of the connectors may be different according to the model.  
Please refer to the wiring diagram to confirm the positions of the connectors.

### 4 Test Run

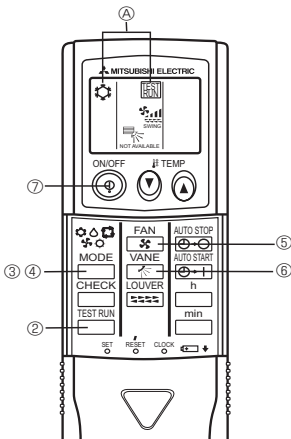

Measure an impedance between the power supply terminal block on the outdoor unit and the ground with a 500V Megger and check that it is equal to or greater than 1.0 MΩ.

- ① Turn on the main power to the unit.
- ② Press the  $\square_{TEST RUN}$  button twice continuously.  
(Start this operation from the status of remote controller display turned off.)  
④ TEST RUN and current operation mode are displayed.
- ③ Press the  $\square_{MODE}$  ( $\odot \odot \odot \odot$ ) button to activate COOL  $\odot$  mode, then check whether cool air is blown out from the unit.
- ④ Press the  $\square_{MODE}$  ( $\odot \odot \odot \odot$ ) button to activate HEAT  $\odot$  mode, then check whether warm air is blown out from the unit.
- ⑤ Press the  $\square_{FAN}$  button and check whether strong air is blown out from the unit.
- ⑥ Press the  $\square_{VANE}$  button and check whether the auto vane operates properly.
- ⑦ Press the ON/OFF button to stop the test run.

NOTE : • Point the remote controller towards the indoor unit receiver while following steps ② to ⑦.  
• It is not possible to run in FAN, DRY or AUTO mode.

## 5 Function Selection

This setting is available only for Mr. Slim model. CITY MULTI model can be set by dip switch of indoor/outdoor control circuit board. Refer to technical data of CITY MULTI model to set dip switch.

Each function can be set according to necessity using the remote controller. The setting of function for each unit can only be done by the remote controller. Select function available from the Table3. Function selection using wireless remote controller is available only for refrigerant system with wireless function. Refrigerant address cannot be specified by the wireless remote controller. The article below describes how to set "LOSSNAY connectivity" into "supported (indoor unit is not equipped with outdoor-air intake)" in Table 3 as an example.

- ① Go to the function select mode  
Press the **CHECK** button (F) twice continuously.  
(Start this operation from the status of remote controller display turned off.)  
CHECK is lighted and "00" blinks.
- ② Setting the unit number  
Press the temp button (C) once to set "50". Direct the wireless remote controller toward the receiver of the indoor unit and press the **h** button (A).
- ③ Selecting a mode  
Enter 03 to change the LOSSNAY connectivity setting using the **temp** button (C) and **h** button (A). Direct the wireless remote controller toward the receiver of the indoor unit and press the **h** button (A).  
Current setting number:  
1=1 beep (1 second)  
2=2 beeps (1 second each)  
3=3 beeps (1 second each)
- \* If a mode number that can not be recognized by the unit is entered, 3 beeps (3 beeps of 0.4 seconds duration) will be heard. Reenter the mode number selecting.
- \* If the signal was not received by the sensor or an error occurred during transmission, you will not hear a beep or a "double beep" may be heard. Press the **h** button again.
- ④ Selecting the setting number  
Use the **temp** button (C) and **h** button (A) to change the LOSSNAY connectivity setting to 02. Direct the wireless remote controller toward the sensor of the indoor unit and press the **h** button (A).  
→ At this time, current setting number for selected mode number will be output by the interrupted buzzer sounds and the blinks of operation indicator.  
Output : setting number = 1 → beep beep (0.4 second + 0.4 second) ×1  
2 → beep beep (0.4 second + 0.4 second) ×2  
3 → beep beep (0.4 second + 0.4 second) ×3
- \* If a setting number that can not be recognized by the unit is entered, 3 beeps (3 beeps of 0.4 seconds duration) will be heard (unit will beep only). Reenter the setting number selecting.
- \* If the signal was not received by the sensor or an error occurred during transmission, you will not hear a beep or a "double beep" may be heard. Press the **h** button again.
- \* If the number that can not be set is input, the former setting number will be set.
- ⑤ To select multiple functions continuously  
Repeat steps ③ and ④ to change multipul function settings continuously.
- ⑥ Complete function selection  
Direct the wireless remote controller toward the sensor of the indoor unit and press the **temp** button (E).

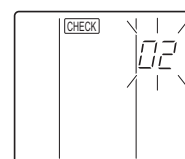
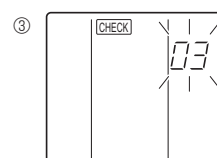
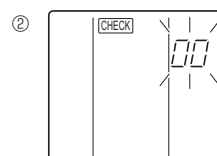
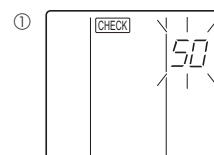
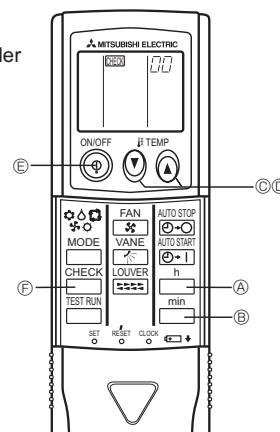

NOTE : Whenever changes are made to the function settings after construction or maintenance, be sure to record the added functions with an "O", in the "Check" column provided on the chart.

Other function selections

Now that you know how to change LOSSANY connectivity setting, there are several other settings that can be changed as well. The following table lists the various settings that can be changed through the remote controller and the default settings.

Table 3.

Function	Settings	PCA-RP-KA
Power failure automatic recovery	Not available	*1
	Available	*1
Indoor temperature detecting	Indoor unit operating average	○
	Set by indoor unit's remote controller	
	Remote controller's internal sensor	
LOSSANY connectivity	Not supported	○
	Supported (indoor unit is not equipped with outdoor-air intake)	
	Not supported (indoor unit is not equipped with outdoor-air intake)	
Auto mode (only for PUHZ)	Energy saving cycle automatically enabled	○
	Energy saving cycle automatically disabled	
Filter sign	100Hr	
	2500Hr	○
	No filter sign indicator	
Fan speed	Quiet	
	Standard	○
	High ceiling	
Up/down vane setting	No vanes	
	Equipped with vanes (No.1 set)	○
	Equipped with vanes (No.2 set)	

\*1 Power failure automatic recovery initial setting depends on the connecting outdoor unit.

Things to remember when entering function selections:

The basic procedure for entering function selections is the same as described for switching between LOSSANY connectivity. However, there are some differences at step ② for selecting the unit number, step ③ for selecting the mode number and step ④ for selecting the setting number.

The following Tables 4 and 5 list the various function settings, mode numbers and setting numbers.

Table 4 details the function of the entire refrigerant system while Table 5 shows the function that can be set for the indoor unit.

Table 4. Itemized functions of the entire refrigerant system (select unit number 00)

Mode	Settings	Mode no.	Setting no.	Check	Remarks
Power failure automatic recovery	Not available	01	1		Approximately 4-minutes wait-period after power is restored.
	Available (Approximately 4-minutes wait-period after power is restored.)		2		
Indoor temperature detecting	Indoor unit operating average	02	1		
	Set by indoor unit's remote controller		2		
	Remote controller's internal sensor		3		
LOSSANY connectivity	Not supported	03	1		
	Supported (indoor unit is not equipped with outdoor-air intake)		2		
	Not supported (indoor unit is not equipped with outdoor-air intake)		3		
Auto mode (only for PUHZ)	Energy saving cycle automatically enabled	05	1		
	Energy saving cycle automatically disabled		2		

Table 5. Itemized functions of the indoor unit (select unit numbers 01 to 04 or 07)

Mode	Settings	Mode no.	Setting no.	Check	Remarks
Filter sign	100Hr	07	1		
	2500Hr		2		
	No filter sign indicator		3		
Fan speed	Quiet	08	1		
	standard		2		
	High ceiling		3		
Up/down vane setting	No vanes	11	1		
	Equipped with vaneas (No.1 set)		2		
	Equipped with vaneas (No.2 set)		3		

② Setting the unit numbers

Set "00" as the unit number when setting function from Table 4.

When setting function from Table 5.

- When setting function for an indoor unit in an independent system, set the unit number to 01.

- When setting function for a simultaneous-Twin Triple quadruple indoor unit system, assign unit numbers from 01 to 04 to each indoor unit.

- When setting the same functions for an entire simultaneous Twin Triple quadruple-indoor unit system, assign "07" as the unit number.

③ Selecting the mode number

Select from Table 4 and Table 5.

④ Selecting the setting number.



## 6 Self-Check

- ① Turn on the main power to the unit.
- ② Press the **CHECK** button twice continuously.  
(Start this operation from the status of remote controller display turned off.)
  - Ⓐ **CHECK** begins to light.
  - Ⓑ «00» begins to blink.
- ③ While pointing the remote controller toward the unit's receiver, press the **h** button. The check code will be indicated by the number of times that the buzzer sounds from the receiver section and the number of blinks of the operation lamp.
- ④ Press the ON/OFF button to stop the self-check.

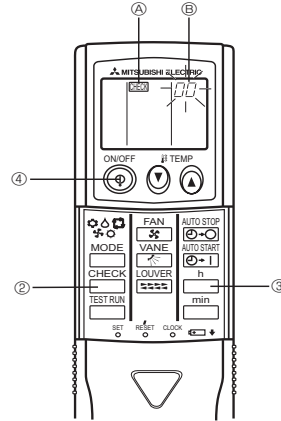

● Refer to the following tables for details on the check codes.

### ① Output pattern (Mr.Slim model / CITY MULTI model)

#### [Output pattern A]

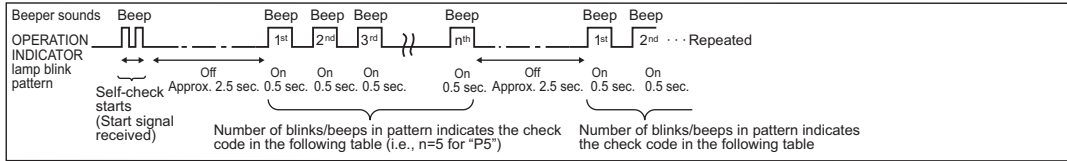

#### [Output pattern B]

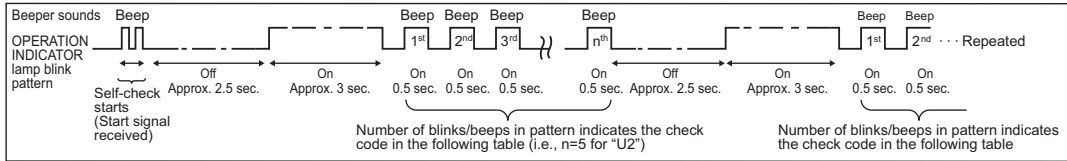

### ② Check code (Mr.Slim model)

#### [Output pattern A] Errors detected by indoor unit

Wireless remote controller	Wired remote controller	Symptom	Remark
Beeper sounds/OPERATION INDICATOR lamp blinks (Number of times)	Check code		
1	P1	Intake sensor error	
2	P2, P9	Pipe (Liquid or 2-phase pipe) sensor error	
3	E6, E7	Indoor/outdoor unit communication error	
4	P4	Drain sensor error/Float switch connector open	
5	P5	Drain pump error	
6	P6	Freezing/Overheating safeguard operation	
7	EE	Communication error between indoor and outdoor units	
8	P8	Pipe temperature error	
9	E4	Remote controller signal receiving error	
10	—	—	
11	—	—	
12	Fb	Indoor unit control system error (memory error, etc.)	
No sound	—	No corresponding	

[Output pattern B] Errors detected by unit other than indoor unit (outdoor unit, etc.)

Wireless remote controller Beeper sounds/OPERATION INDICATOR lamp blinks (Number of times)	Wired remote controller Check code	Symptom	Remark
1	E9	Indoor/outdoor unit communication error (Transmitting error) (Outdoor unit)	For details, check the LED display of the outdoor controller board.
2	UP	Compressor overcurrent interruption	
3	U3,U4	Open/short of outdoor unit thermistors	
4	UF	Compressor overcurrent interruption (When compressor locked)	
5	U2	Abnormal high discharging temperature/insufficient refrigerant	
6	U1,Ud	Abnormal high pressure (63H worked)/Overheating protection operation	
7	U5	Abnormal temperature of heat sink	
8	U8	Outdoor unit fan protection stop	
9	U6	Compressor overcurrent interruption/Abnormal of power module	
10	U7	Abnormality of super heat due to low discharge temperature	
11	U9,UH	Abnormality such as overvoltage or voltage shortage and abnormal synchronous signal to main circuit/Current sensor error	
12	-	-	
13	-	-	
14	Others	Other errors (Refer to the technical manual for the outdoor unit.)	

\*1 If the beeper does not sound again after the initial 2 beeps to confirm the self-check start signal was received and the OPERATION INDICATOR lamp does not come on, there are no error records.

\*2 If the beeper sounds 3 times continuously "beep, beep, beep (0.4 + 0.4 + 0.4 sec.)" after the initial 2 beeps to confirm the self-check start signal was received, the specified refrigerant address is incorrect.

- On wireless remote controller  
The continuous buzzer sounds from receiving section of indoor unit.  
Blink of operation lamp
- On wired remote controller  
Check code display in the LCD.

③ Check code (CITY MULTI model)

[Output pattern A] Errors detected by indoor unit or LOSSNAY unit

[Output pattern B] Errors detected by unit other than indoor unit (outdoor unit, etc.)

Wireless remote controller Beeper sounds/OPERATION INDICATOR lamp blinks (Number of times)	Wired remote controller Check code	Remark
1	1000 ~ 1999	
2	2000 ~ 2999	
3	3000 ~ 3999	
4	4000 ~ 4999	
5	5000 ~ 5999	
6	6000 ~ 6999	
7	7000 ~ 7999	
8	0000 ~ 0999	
9	8000 over	

\*1 Refer to service handbook of outdoor unit for the detail.

\*2 If the beeper does not sound again after the initial 2 beeps to confirm the self-check start signal was received and the OPERATION INDICATOR lamp does not come on, there are no error records.

\*3 If the beeper sounds 3 times continuously "beep, beep, beep (0.4 + 0.4 + 0.4 sec.)" after the initial 2 beeps to confirm the self-check start signal was received, the specified address is incorrect.

- On wireless remote controller  
The continuous buzzer sounds from receiving section of indoor unit.  
Blink of operation lamp
- On wired remote controller  
Check code display in the LCD.