

## 2.4/5 GHz Micro Omni MIMO Antenna with 2.5/4 dBi Gain and 4 RPTNC leads

Ventev's TerraWave Dual Band Micro Omni MIMO Antenna is optimized for small form factor/aesthetic and mobile Wi-Fi applications. This aesthetically-pleasing antenna includes four dual-band Wi-Fi pigtails and RPTNC connectors. The antenna is an ideal partner for four connector dual-band Wi-Fi access points where low profile and/or aesthetics is a major deployment consideration. This multi-use antenna can also be used in vehicles for communications, location tracking, and fleet management. *Every TerraWave antenna is covered by the company's two-year TerraNet warranty program. For more information, contact a regional sales executive at 210-375-8482, 800-851-4965 or [sales@terrawave.com](mailto:sales@terrawave.com), or visit [www.terrawave.com](http://www.terrawave.com).*



<b>Specifications</b>		
Model	M602504003D402MW	
Frequency Range	2400-2500 MHz	4900 - 5850 MHz
Bandwidth	100 MHz	950 MHz
Gain	2.5 dBi	4 dBi
VSWR	≤2	≤2
Impedance	50 ohms	
Polarization	Vertical	
Power	50 watts	
Connector	RPTNC male	
Port number	4	
Size	3.54" x 1.57"	
Weight	4.4 oz	
Operating Temperature	-40° F to +158° F	
Mounting Method	Surface Mount	

## 2.4/5 GHz Micro Omni MIMO Antenna with 2.5/4 dBi Gain and 4 RPTNC leads

### Installation

#### Outdoor Car Roof Installation

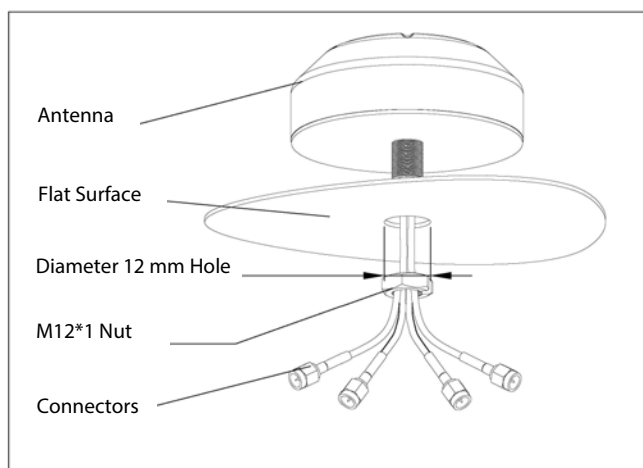

#### Indoor Ceiling Mount Installation

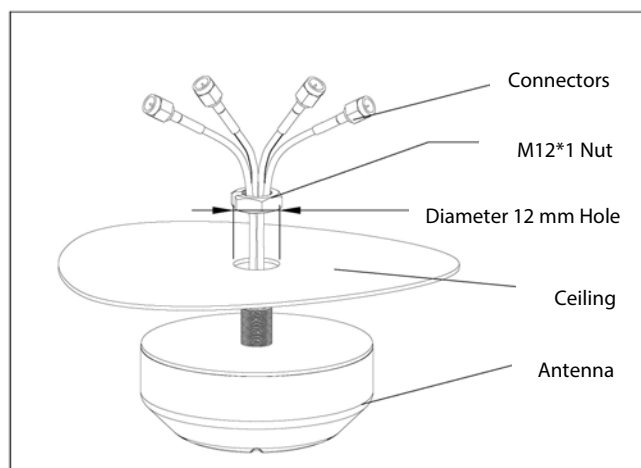

**Note: The TerraWave SKU 509824 provides an L-Bracket mounting alternative for mast or wall mounting (sold separately)**

# 2.4/5 GHz Micro Omni MIMO Antenna with 2.5/4 dBi Gain and 4 RPTNC leads

## Radiation Patterns

Port 1: 2450MHz

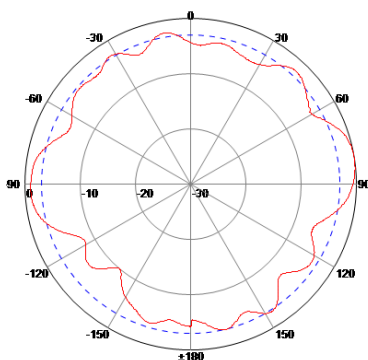

H Plane

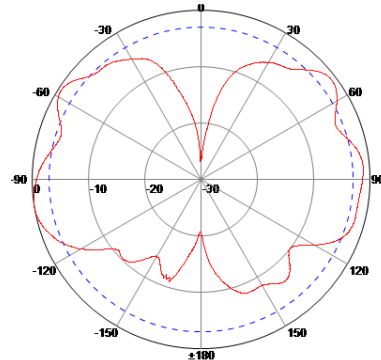

E Plane

Port 1: 5500MHz

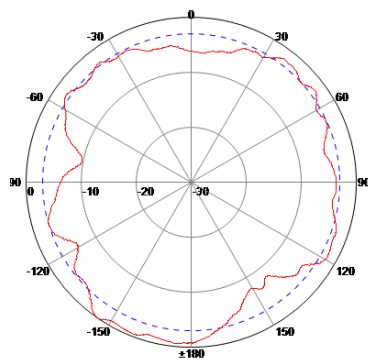

H Plane

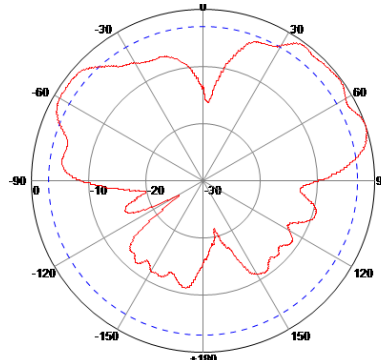

E Plane

Port 2: 2450MHz

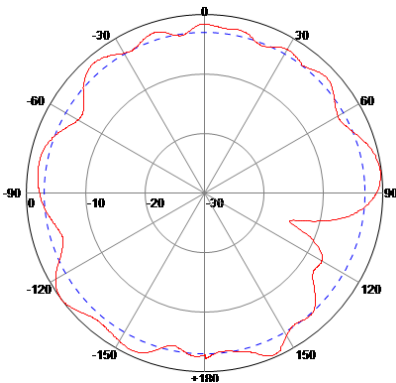

H Plane

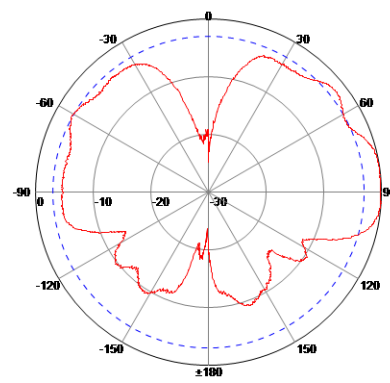

E Plane

# 2.4/5 GHz Micro Omni MIMO Antenna with 2.5/4 dBi Gain and 4 RPTNC leads

Port 2: 5500MHz

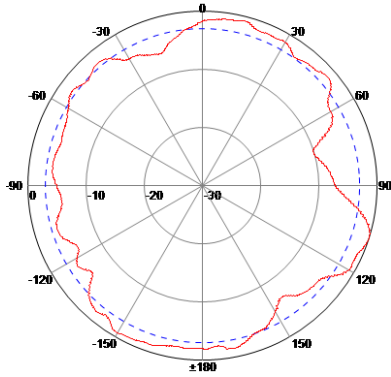

H Plane

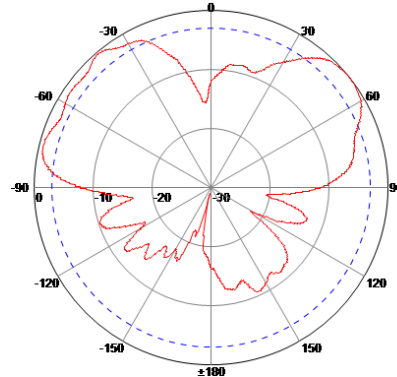

E Plane

Port 3: 2450MHz

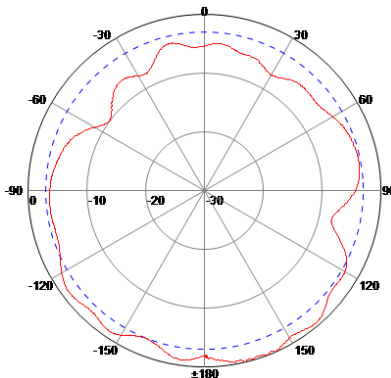

H Plane

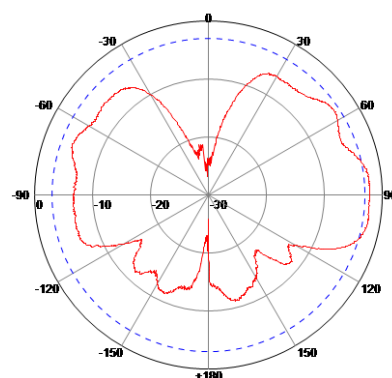

E Plane

Port 3: 5500MHz

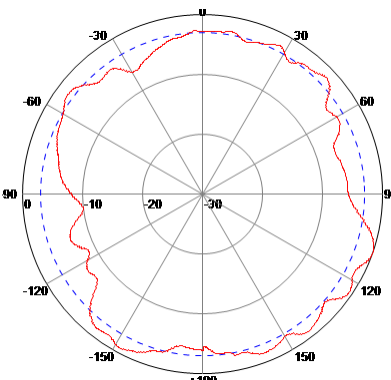

H Plane

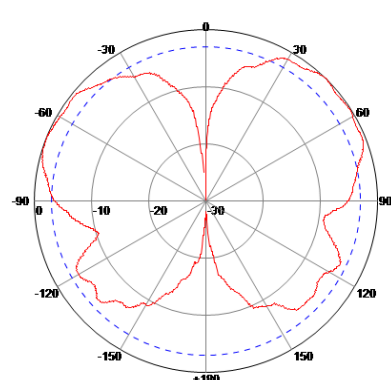

E Plane

## 2.4/5 GHz Micro Omni MIMO Antenna with 2.5/4 dBi Gain and 4 RPTNC leads

Port 4: 2450MHz

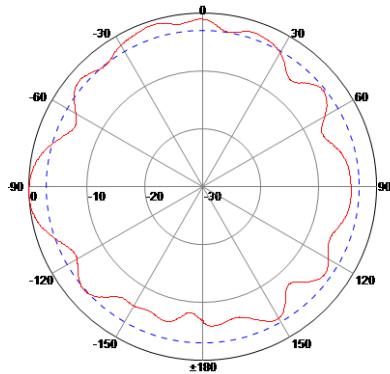

H Plane

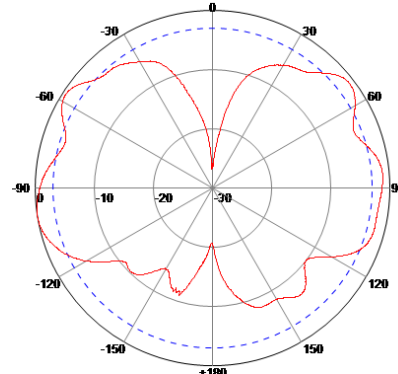

E Plane

Port 4: 5500MHz

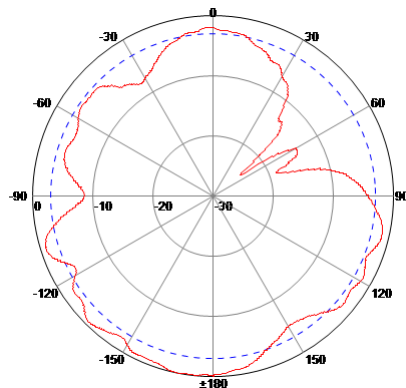

H Plane

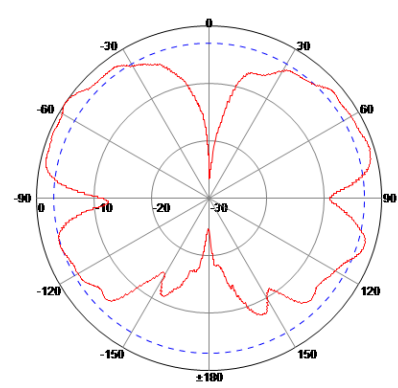

E Plane