

Panasonic®

User Manuals Wired Remote Control

CZ-RD516C

ENGLISH

F568357

WIRED REMOTE CONTROL

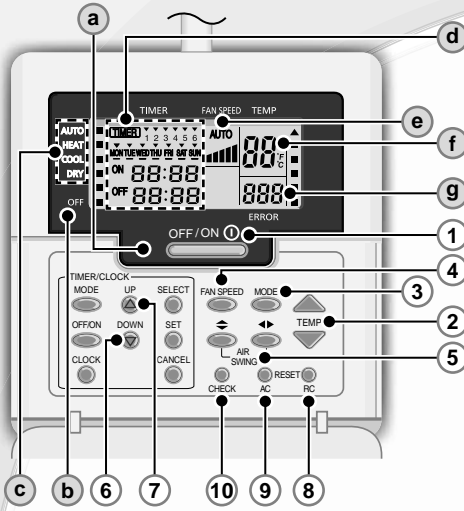

Remote Control Display

- a** OPERATION LED
- b** OFF INDICATOR
- c** OPERATION MODE SELECTION INDICATOR
- d** TIMER/CLOCK SETTING DISPLAY

Lights up if Timer operation is selected

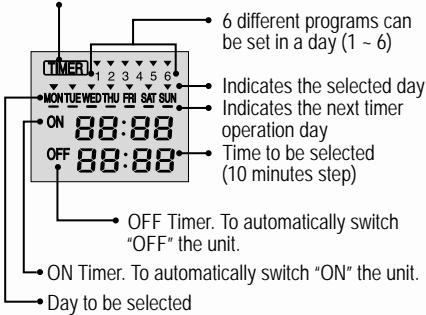

- e** FAN SPEED DISPLAY
- f** TEMPERATURE SETTING DISPLAY
- g** ERROR CODE DISPLAY

Remote Control Preparation

1. Press **CLOCK**
2. Press **UP** or **DOWN**
3. Press **SET** to confirm.
4. Repeat steps 2 and 3 to set the current time.

Press the remote control's button

1 TO TURN ON OR OFF THE UNIT

- Please be aware of the OFF indication on the remote control display to prevent the unit from starting/stopping improperly.

2 TO SET TEMPERATURE

- Selection range: 60°F ~ 86°F.

3 TO SELECT OPERATION MODE

AUTO mode - For your convenience

- Unit selects operation mode during startup according to temperature setting and room temperature.

HEAT mode - To enjoy warm air

- Unit takes a while to warm up. The power indicator blinks during this operation.

COOL mode - To enjoy cool air

- Use curtains to screen off sunlight and outdoor heat to reduce power consumption during cool mode.

DRY mode - To dehumidify the environment

- Unit operates at low fan speed to give a gentle cooling operation.

4 TO SELECT FAN SPEED (5 OPTIONS)



- For AUTO, the indoor fan speed is automatically adjusted according to the operation mode.

5 TO ADJUST AIRFLOW DIRECTION

- Keeps the room ventilated.
- In COOL/DRY mode, if AUTO is set, the louver swing left/right and up/down automatically.
- In HEAT mode, if AUTO is set, the horizontal louver fix at predetermined position. The vertical louver swing left/right after the temperature rises.
- For Hide-Away models, AIR SWING buttons are not in use. Airflow direction can not be adjusted.

6 Press and hold for approximately 10 seconds to show temperature setting in °C or °F.

7 Press and hold for 5 seconds to dim or restore the unit's indicator brightness.

8 Press to restore the remote control's default setting.

9 Not used in normal operations.

10 Retrieve error code.

- During operation, the unit stops and both **a** and **b** is OFF indicates abnormality occurs.

1. Ensure **a** is OFF, press **CHECK** for 5 seconds.

2. Press **UP** or **DOWN**. If error code and abnormality can be identified, **a** will be ON continuously, then write down the error code.



3. Press **CHECK** for 5 seconds to quit checking.

4. Turn the unit off and reveal the error code to authorized dealer.

DAILY TIMER SETTING

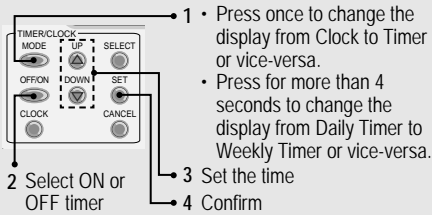
- To turn ON or OFF the unit at a preset time.













- To cancel ON or OFF timer, press .
- Timer operation is based on the clock set in the remote control and repeats daily once set.
- The timer closest to the current time will be activated first.
- If timer is cancelled manually or due to power failure, you can restore the previous setting by pressing .

WEEKLY TIMER SETTING

- Daily timer and weekly timer could not be set at the same time.
- Promotes energy saving by allowing you to set up to 6 programs in any given day.

1. Press Timer  for 4 seconds to change display to weekly timer.









2. Press Timer  or  to select your desired day.
 3. Press  to confirm your selection.
 4. "1" will be blinking, press  to set program 1.
 5. Press Timer  to select ON or OFF timer.
 6. Press Timer  or  to select your desired time. If you want to set the timer together with your desired temperature, press  to select the temperature.
 7. Press  to confirm program 1. The selected day will be highlighted with .
- After 2 seconds, the display will move to the next program. Repeat steps 4 to 7 to set programs 2 to 6.
 - Same timer program cannot be set in the same day.
 - During timer setup, if no button is pressed within 30 seconds, or if the  button is pressed, the setting at that moment is confirmed and timer setup is ended.

OPERATION DETAILS





The timer setting will shown at wired remote control only but not at indoor unit's TIMER indicator.

Check Current Timer Program

Perform the step below to check the timer program for a particular day.









1. Press Timer  to enter timer mode.
2. Press  to enter day setting.
3. Press Timer  or  until your desired day is shown, press  to confirm your selection.
4. Press Timer  or  to check the set programs.

Modify Current Timer Program or Add New Timer Program





1. Press Timer  to enter timer mode.
2. Press  to enter day setting.
3. Press Timer  or  until your desired day is shown.
4. Perform steps 4 to 7 of "WEEKLY TIMER SETTING" to modify existing timer program, or add any timer program.

Cancel Current Timer Program

Perform the step below to cancel the timer program for a particular day.

1. Press  to enter day.
2. Press Timer  or  until your desired day is shown.
3. Press  to enter program setting.
4. Press Timer  or  until your desired program is shown. Press  to cancel the program,  will disappear.

Disable & Enable Weekly Timer

- To disable weekly timer setting, press , then press .
- To enable previous weekly timer setting, press , then press .

NOTE

- POWERFUL, QUIET operation setting could be operate according to wireless remote control.
- When wired remote control is in operation, the timer setting from wireless remote control will be cancelled.

Federal Communications Commission Interference Statement

This device complies with part 15 of the FCC Rules. Operation is subject to the following two conditions: (1) This device may not cause harmful interference, and (2) this device must accept any interference received, including interference that may cause undesired operation.

This equipment has been tested and found to comply with the limits for a Class B digital device, pursuant to part 15 of the FCC Rules. These limits are designed to provide reasonable protection against harmful interference in a residential installation. This equipment generates, uses and can radiate radio frequency energy and, if not installed and used in accordance with the instructions, may cause harmful interference to radio communications. However, there is no guarantee that interference will not occur in a particular installation. If this equipment does cause harmful interference to radio or television reception, which can be determined by turning the equipment off and on, the user is encouraged to try to correct the interference by one or more of the following measures:

- Reorient or relocate the receiving antenna.
- Increase the separation between the equipment and the receiver.
- Connect the equipment to an outlet on a circuit different from that to which the receiver is connected.
- Consult the dealer or an experienced radio/TV technician for help.

FCC Caution: To assure continued compliance, follow the attached installation instructions. Any changes or modifications not expressly approved by the party responsible for compliance could void the user's authority to operate this equipment.

Industry Canada Notice

This Class B digital apparatus complies with Canadian ICES-003.

Panasonic Corporation

Website: <http://panasonic.net/>

Printed in China

For inquiries, please call 1-800-851-1235

F568357
SS1011-0