



Patent pending CFSA35606P

CFSA35606P1

The CFSA35606P/CFSA35606P1 is a low PIM indoor wideband omnidirectional low-profile ceiling mount antenna. It is designed to provide pattern coverage that is optimized for indoor coverage requirements at 350-520, 600-960, 1350-1550, and 1690-6000 MHz for the UHF, 4G LTE, 2G/3G Cellular, UMTS/AWS-3, CBRS, and the Wi-Fi frequency bands. The CFSA35606P/CFSA35606P1 are applicable for environments where aesthetics and wide-angle coverage are necessary for successful wireless deployment. The surprisingly small size and extreme low profile enables maximum mounting flexibility while maintaining desired in-building aesthetics.

### FEATURES AND BENEFITS

- Ultra-low profile
- Public safety iDAS
- Optimized performance using Laird proprietary tools
- Aesthetically-neutral housing
- Supports AWS-3 frequency band
- Mounts directly and easily to ceiling tile (CFSA35606P1 is for hard ceiling mounting)

### APPLICATIONS

- FirstNet/Public Safety
- In-building DAS

### ELECTRICAL SPECIFICATIONS

Operating Frequency (MHz)	350-380	380-520	600-698	698-806	806-894	894-960	1350-1550	1690-1880	1850-1990	1910-2180	2300-2700	3300-4200	4900-5925	
Gain (dBi)	4.5	4.4	3.7	4.0	4.2	4.6	5.6	5.4	4.1	5.0	5.7	6.8	7.3	
VSWR- Avg.	1.9	1.7	1.7	1.5	1.3	1.5	1.3	1.4	1.4	1.4	1.5	1.4	1.7	
VSWR – Max	<2.5:1		<2.0:1											
PIM - 2x20W (dBc)	< -150		< -150								< -150			
Nominal Impedance (Ohms)	50													
Max Power - Ambient 25°C (W)	50													
Polarization	Horizontal													
Azimuth Beamwidth	360°, Omnidirectional													

### MECHANICAL SPECIFICATIONS

Dimensions – height x diameter – mm (inches)	7.6 x 270 (0.30 x 10.6)
Weight – kg (lbs.)	0.46 (1.01)
Antenna Color	White
Radome Material	PC, UV Stable, UL 94-V0 Material

### ENVIRONMENTAL SPECIFICATIONS

Operating Temperature – °C (°F)	-30 to +70°C (-22 to +158°F)
Storage Temperature – °C (°F)	-40 to +85°C (-40 to +185°F)
Material Substance Compliance	RoHS

### CONFIGURATION

PART NUMBER	CABLE LENGTH	CONNECTOR	MOUNTING
CFSA35606P-30NF	30 cm (12")	Type N- female	Ceiling Tile
CFSA35606P-30D43F	30 cm (12")	4.3-10 female	Ceiling Tile
CFSA35606P1-30NF	30 cm (12")	Type N- female	Hard Ceiling
CFSA35606P1-30D43F	30 cm (12")	4.3-10 female	Hard Ceiling

MECHANICAL DRAWING

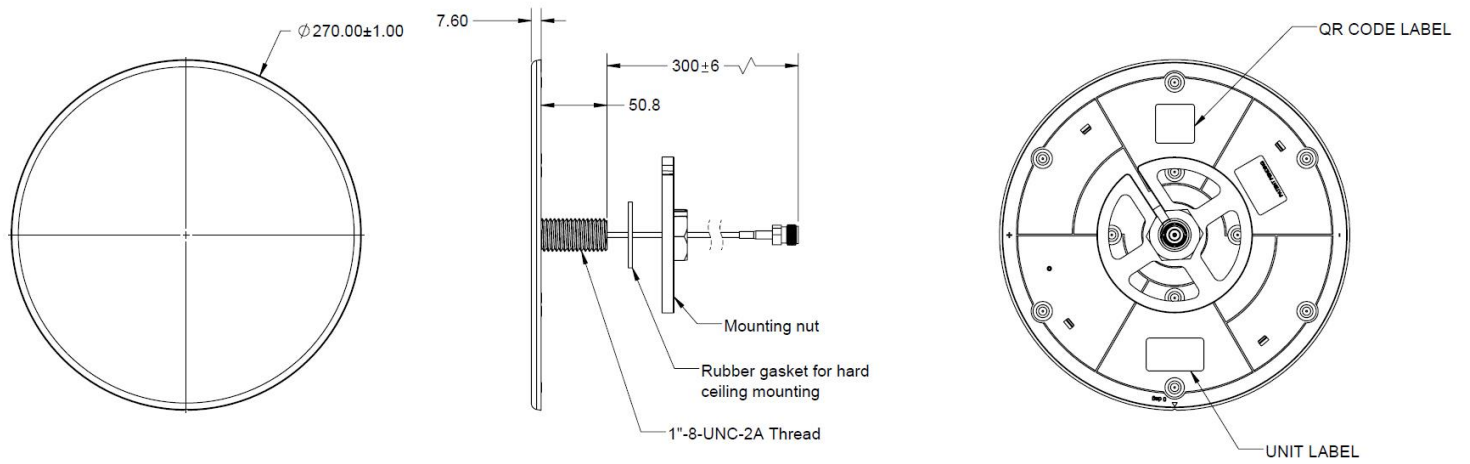

Figure 1: CFSA35606P Mechanical drawings

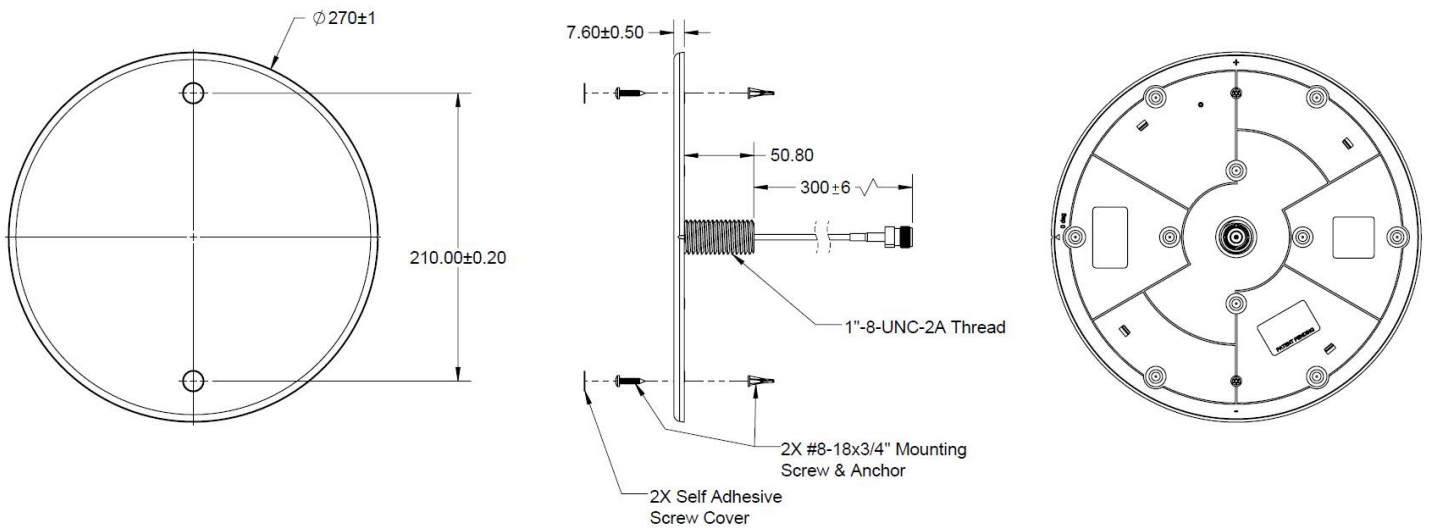
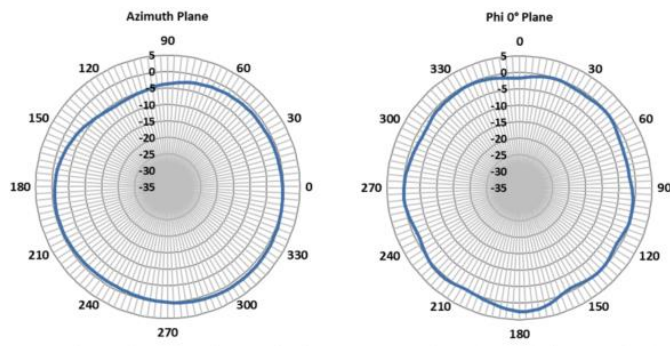
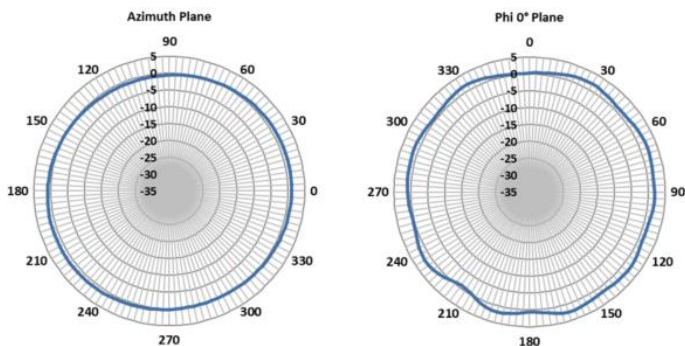

Figure 2: CFSA35606P1 Mechanical drawings

RADIATION PATTERNS

430 MHz

600 MHz



806 MHz

960 MHz

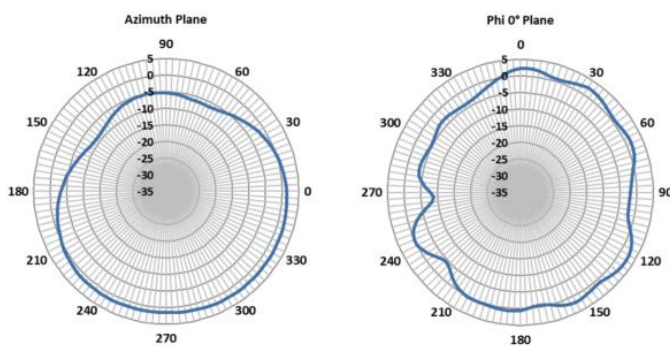
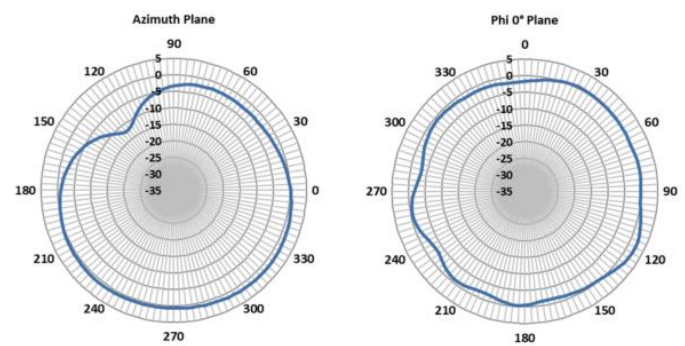

1500 MHz

1850 MHz

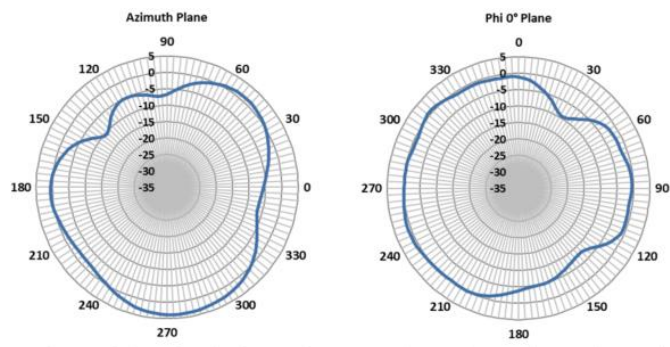
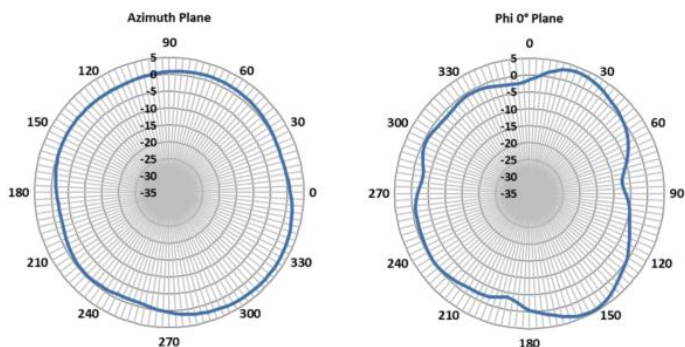

RADIATION PATTERNS

2170 MHz

2500 MHz

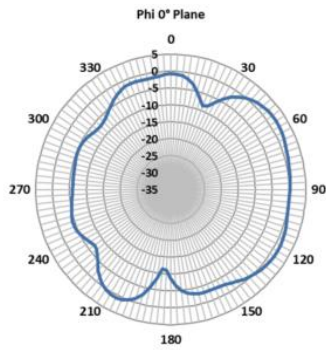
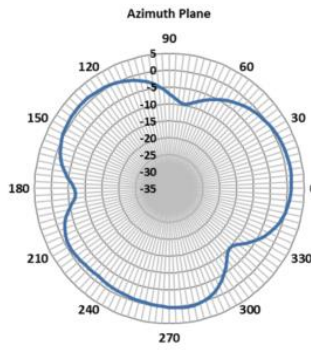
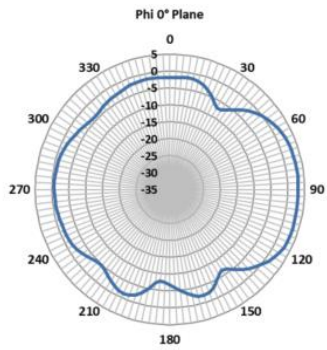
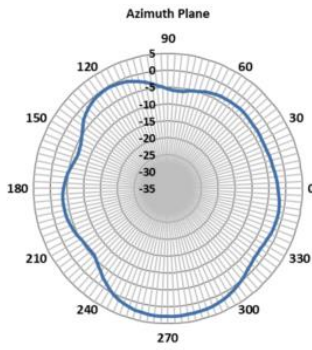

3500 MHz

5900 MHz

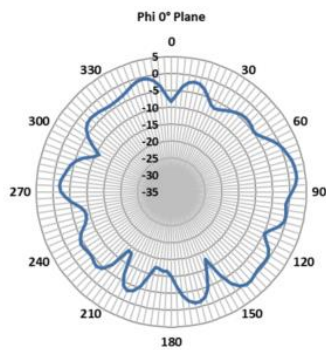
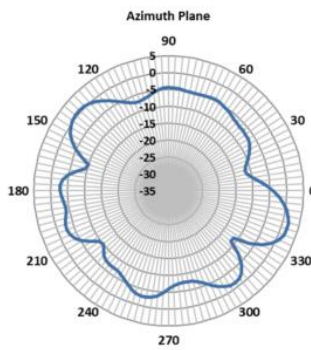
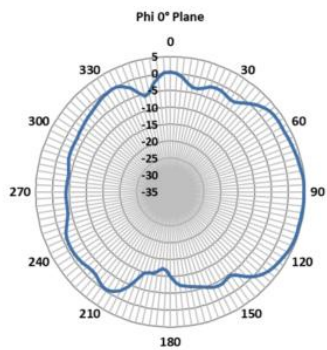
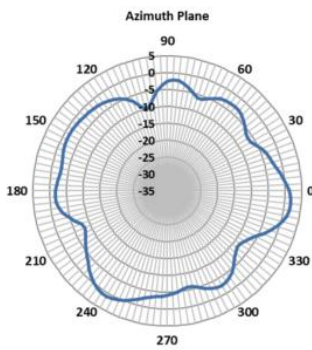

**Note:** Azimuth patterns represent 45° conic cuts.

✓RoHS

Americas: +1.847.839.6925  
IAS-AmericasSales@lairdtech.com  
Europe: +44.1628.858941  
IAS-EUSales@lairdtech.com  
Asia: IAS-AsiaSales@lairdtech.com  
Middle East and Africa: +44.1628.858941  
IAS-MEASales@lairdtech.com  
<https://connectivity.lairdtech.com/>

Laird warrants to the original end user customer of its products that its products are free from defects in material and workmanship. Subject to conditions and limitations Laird will, at its option, either repair or replace any part of its products that prove defective because of improper workmanship or materials. This limited warranty is in force for the useful lifetime of the original end product into which the Laird product is installed. Useful lifetime of the original end product may vary but is not to exceed five (5) years from the original date of the end product purchase.

Any information furnished by Laird Inc. and its agents is believed to be accurate and reliable. All specifications are subject to change without notice. Responsibility for the use and application of Laird materials rests with the end user, since Laird and its agents cannot be aware of all potential uses. Laird makes no warranties as to the fitness, merchantability or suitability of any Laird materials or products for any specific or general uses. Laird shall not be liable for incidental or consequential damages of any kind. All Laird products are sold pursuant to the Laird Terms and Conditions of sale in effect from time to time, a copy of which will be furnished upon request.

© Copyright 2018 Laird Inc. All Rights Reserved. Laird, Laird Technologies, the Laird Logo, and other marks are trademarks or registered trademarks of Laird Inc. or an affiliate company thereof. Other product or service names may be the property of third parties. Nothing herein provides a license under any Laird or any third party intellectual property rights.

